

# **Multi-Function Test System MTS ME 3.1KM**

**User's Manual**

**Edition 3**

MC2.702.500 UM

2016

# TABLE OF CONTENTS

<b>INTRODUCTION .....</b>	<b>3</b>
<b>1 SAFETY REQUIREMENTS .....</b>	<b>3</b>
<b>2 DESCRIPTION AND OPERATING PRINCIPLES .....</b>	<b>3</b>
<b>2.1 Sphere of application .....</b>	<b>3</b>
<b>2.2 Description of the system and its modules.....</b>	<b>4</b>
2.2.1 Switchgear Module CS-3.1.....	7
2.2.2 Inductive Voltage Divider IVD-3.1 .....	8
2.2.3 Waveform Generator Energoforma 3.1.....	9
2.2.4 Reference standard Energomonitor 3.1KM .....	10
2.2.5 Current Amplifier CA-3.1.....	11
2.2.6 Voltage Amplifier VA-3.1 .....	12
2.2.7 Error Calculation Unit Calmar-SL.....	13
2.2.8 Calibrated Coils .....	13
2.2.9 DC Power Supply.....	14
<b>2.3 Design and operation.....</b>	<b>18</b>
2.3.1 Reference standard Energomonitor 3.1KM .....	19
2.3.2 Three-phase Programmable Waveform Generator Energoforma 3.1 .....	19
2.3.3 Current Amplifier CA-3.1.....	19
2.3.4 Voltage Amplifier VA-3.1 .....	20
2.3.5 DC Power Supply.....	20
2.3.6 Switchgear module CS-3.1 .....	20
2.3.7 Error calculation unit Calmar-SL.....	20
2.3.8 Calibrated Coils .....	21
2.3.9 Inductive voltage divider.....	21
<b>3 PREPARING FOR OPERATION.....</b>	<b>22</b>
3.1 Notes on operating conditions.....	22
3.2 Turning on.....	22
<b>4 OPERATION .....</b>	<b>23</b>
<b>4.1 PC-controlled operation .....</b>	<b>23</b>
<b>4.2 Operation in standalone mode.....</b>	<b>23</b>
4.2.1 Energoforma 3.1 - operator interface .....	23
4.2.3 Energoforma 3.1 - “Standard signal” menu.....	26
4.2.4. Energoforma 3.1 - “Special signals” menu .....	27
4.2.5. Energoforma 3.1 - Settings menu.....	34
4.2.6. Energoforma 3.1 - Signal Library Menu.....	34
<b>5. TECHNICAL SUPPORT .....</b>	<b>37</b>
<b>APPENDIX A CONNECTION DIAGRAMS .....</b>	<b>38</b>
<b>APPENDIX B 3-POSITION AUTOMATIC TEST SYSTEM .....</b>	<b>43</b>
<b>APPENDIX C SOFTWARE .....</b>	<b>44</b>

# INTRODUCTION

This User's Manual describes a multi-functional test system MTS ME 3.1KM (the test system below) manufactured in compliance with Technical Specifications TS 4381-053-49976497-2013.

## 1 SAFETY REQUIREMENTS

1.1 While the test system is being used as intended, the “Interbranch rules for Labour Safety (Safety Rules) When Operating Electrical Systems” (M., Energoatomizdat, 2001) and the corresponding local electrical safety requirements must be observed.

The symbol



placed on the test system components is intended to alert the user to the presence of important operating instructions. See section 3, “Turning on”.

1.2 The test system is operated according to the safety requirements specified in IEC 61010-1; Measurement category: II; degree of protection against pollution: 1.

1.3 IEC 60529 protection code: IP20.

1.4 The components of the test system (the modules below) must be connected to the grounding bus before applying power to the test system.

## 2 DESCRIPTION AND OPERATING PRINCIPLES

### 2.1 Sphere of application

The multi-functional test system MTS ME 3.1KM is designed to measure electrical parameters such as active, reactive and apparent power, AC frequency, current and voltage, phase angles, power factor, and power quality parameters, including (but not limited to):

- RMS of the fundamental harmonic of voltage ( $U_{C1}$ )
- RMS of the voltage harmonic of order  $h$  (frequency  $h \cdot f_1$ ),  $h = 2 \dots 50$  ( $U_{Ch}$ )
- RMS of the voltage interharmonic of order  $m$  (frequency  $m \cdot f_1$ ),  $m = 0.5 \dots 50.5$  in 1.0 increments ( $U_{Cm}$ )
- RMS of the fundamental harmonic of current ( $I_{C1}$ )
- RMS of the current harmonic of order  $h$ ,  $h = 2 \dots 50$  ( $I_{Ch}$ )
- RMS of the current interharmonic of order  $m$  (frequency  $m \cdot f_1$ ),  $m = 0.5 \dots 50.5$  in 1.0 increments ( $I_{Cm}$ )
- Phase angle between the voltage harmonic of order  $h$  and the current harmonic of order  $h$  in the same phase
- Voltage harmonic of order  $h$  in reference to fundamental harmonic,  $h = 2 \dots 50$  [ $K_U(h)$ ]
- Current harmonic of order  $h$  in reference to fundamental harmonic,  $h = 2 \dots 50$  [ $K_I(h)$ ]
- Active power of the fundamental harmonic ( $P_1$ )
- Reactive power of the fundamental harmonic ( $Q_1$ )

- Active power of the harmonic of order  $h$ ,  $h=2\dots 50$  ( $P_{(h)}$ )
- Total Harmonic Distortion of voltage ( $THD_U$ )
- Total Harmonic Distortion of current ( $THD_I$ )
- Positive sequence voltage of the fundamental ( $U_1$ )
- Zero sequence voltage of the fundamental ( $U_0$ )
- Negative sequence voltage of the fundamental ( $U_2$ )
- Negative sequence voltage ratio ( $K_{2U}$ ) and zero sequence voltage ratio ( $K_{0U}$ )
- Positive sequence current of the fundamental ( $I_1$ )
- Zero sequence current of the fundamental ( $I_0$ )
- Negative sequence current of the fundamental ( $I_2$ )
- Phase angle between the voltage and current of positive, or negative, or zero sequence
- Flicker short-term severity
- Duration of voltage dip ( $\Delta t_d$ )
- Depth of voltage dip ( $\delta U_d$ )
- Height of voltage swell ( $K_{sw U}$ )
- Duration of voltage swell ( $\Delta t_{sw}$ )

MTS ME 3.1KM is a test system applied to accuracy testing and calibration of the instruments measuring the electrical parameters listed above. It can also be used for generation of these parameters. Typical applications include metrological (test) laboratories at industrial enterprises.

## 2.2 Description of the system and its modules

The reference instruments included in the test system utilize analogue-to-digital conversion principle, so that input currents and voltages are converted into digital codes from which the arrays of sampled instantaneous values are created. The arrays are used by firmware (stored in the EEPROM memory of the central processor unit) to make all programmed calculations.

The test system can be used for calibration and accuracy testing of the following single- and three-phase instruments:

- Active and reactive energy meters
- Wattmeters, varmeters, active and reactive power converters
- Phase meters, frequency meters, power factor meters
- Voltmeters, ammeters, voltage and current measuring converters
- Power quality meters
- Instruments measuring DC voltage, current and power

The test system is supplied as a complete calibrator's workstation capable of operating in 2 modes:

- PC-controlled mode (with use of standard communications interfaces and Windows-based software)
- Stand-alone mode that implies manual control via the keypads and displays of the Energomonitor and Energoforma modules

Parameters and waveforms being measured and/or generated can be viewed either on the displays of the Energomonitor and Energoforma modules (respectively) or on a PC.

The test system is powered from a mains supply ( $220 \pm 22$  V,  $50 \pm 2.5$  Hz,  $THD \leq 5\%$ ).

The test system is offered in various options with respect to output AC (DC) current, voltage and power ranges.

The test system includes the following components:

- Reference measuring instrument – multifunctional reference standard Energomonitor 3.1KM (registered with National Registry of measuring instruments under # 52854-13)

- Test Signal Source

The Test Signal Source consists of:

- Programmable Waveform Generator Energoforma 3.1 (1 unit)
- Switchgear Module CS-3.1 (1 unit)
- Current Amplifiers CA-3.1 (3 units) and Voltage Amplifier VA-3.1 (1 unit.)

- Inductive Voltage Divider (three-phase, optional) IVD-3.1
- DC Power Supply (optional)

The Test Signal Source and reference instrument of stationary type are mounted in the equipment rack.

MTS ME 3.1KM legend (shown below) contains information about the options as specified in the purchase order:

MTS ME 3.1KM-S-XX-XXX-XX/XXX-X/XXX TS 4381-053-49976497-2013  
1      2      3      4

Position 1 relates to accuracy (depending on the reference standard):

- 02 – (includes Energomonitor 3.1KM S-02 of accuracy class 0.02)
- 05 – (includes Energomonitor 3.1KM S-05 of accuracy class 0.05)
- 10 – (includes Energomonitor 3.1KM S-10 of accuracy class 0.1 or Energomonitor 3.3T1)
- 02D – (includes Energomonitor-3.1KM S-02-1XX and optional DC Power Supply)

Position 2 relates to the maximum value of generated current ( $I_{max}$ , A):

- 7.7
- 110
- 120

Position 3 relates to the power output of the current/voltage channels (VA):

- 25/50
- 45/200
- 15/5
- 45/100

Position 4 relates to the output voltage range ( $U_{min}/U_{max}$ , V):

- 6/264 (6...264 V) (nominal values of phase / phase-to-phase voltage, V: 60/60·√3 and 220/220·√3)
- 6/528 (6...528 V) (nominal values of phase / phase-to-phase voltage, V: 60/60·√3, 220/220·√3 and 480/480·√3)
- 0.1/528 (0.1...528 V) (nominal values of phase / phase-to-phase voltage, V: 60/60·√3, 220/220·√3 and 480/480·√3) – the set includes Voltage Divider IVD-3.1 with division factors 1/10 and 1/100

The general view of the test system is shown in Fig. 3.1.

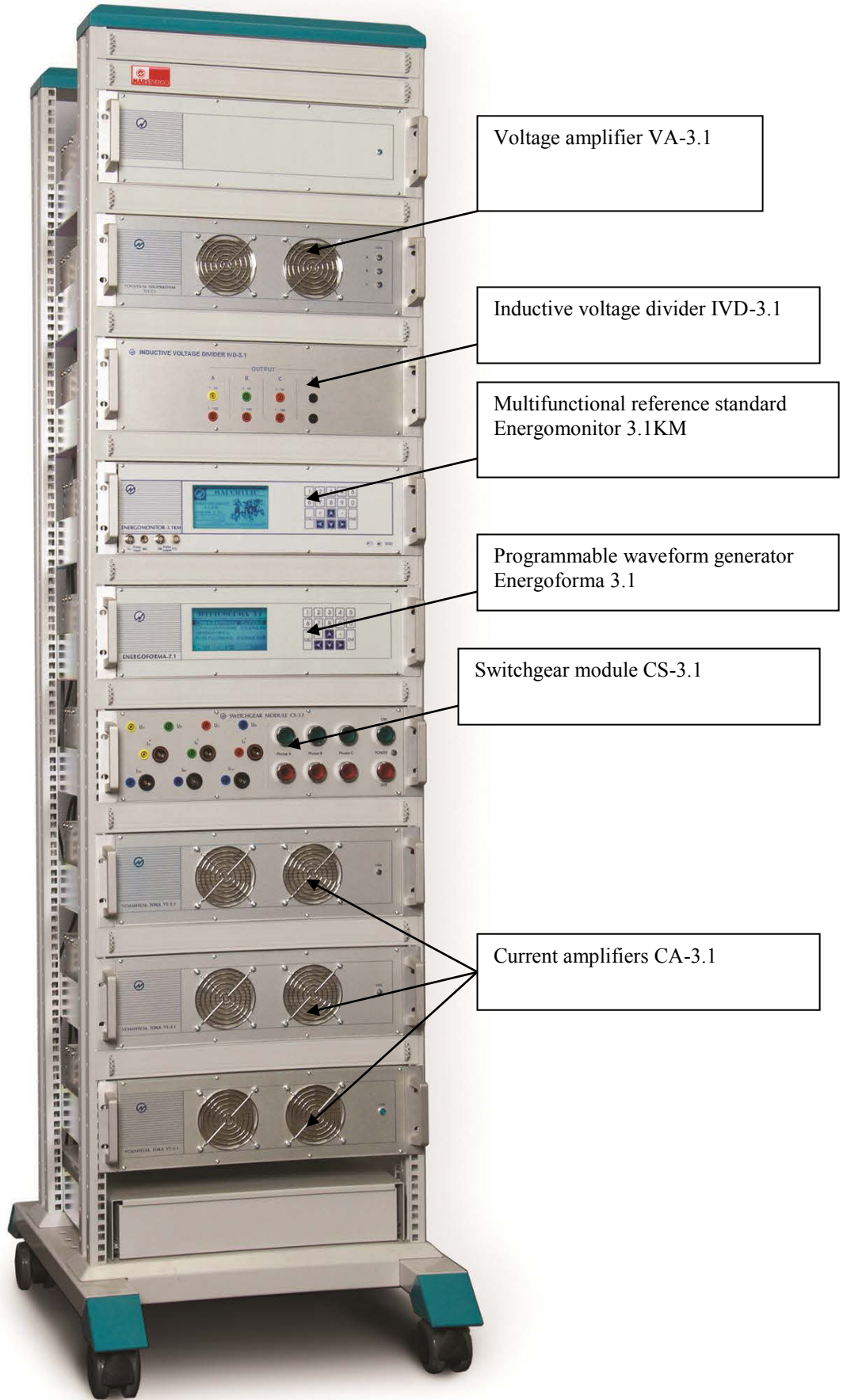
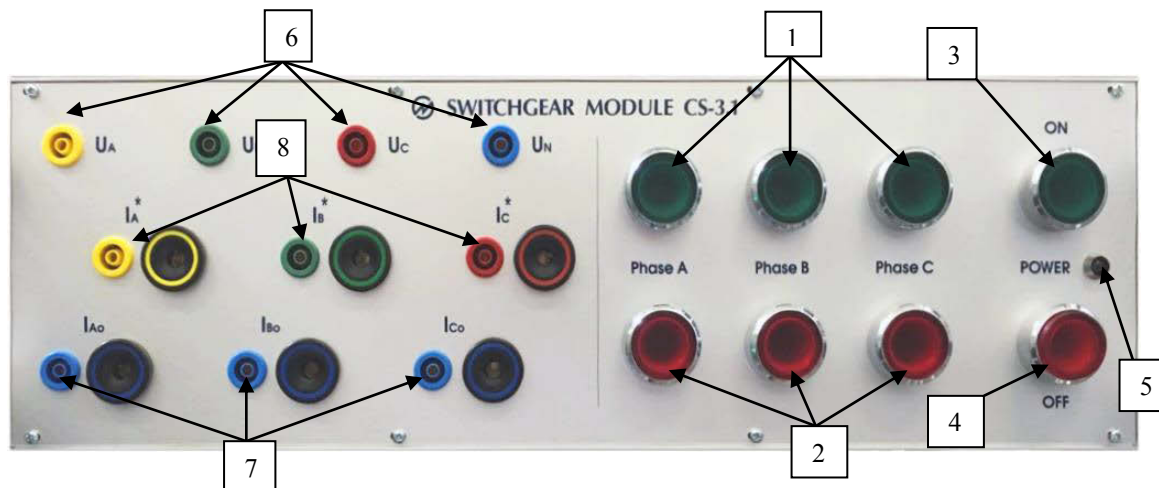

Fig. 1.1 General view

### 2.2.1 Switchgear Module CS-3.1

The front panel is pictured in Fig. 2.1.



**Fig. 2.1** CS-3.1 Front panel

1 — “Power ON” buttons (when pressed, glow green showing that power is applied to the Current and Voltage amplifiers- to phases A, B, and C); 2 — “Power OFF” buttons (when pressed, glow red showing that power is removed from the Current and Voltage amplifiers- from phases A, B, and C);

3 — “Power ON” button (when pressed, glows green showing that power is applied to the Energoforma 3.1 generator and Energomonitor 3.1KM reference meter; 4 — “Power OFF” button (when pressed, glows red showing that power is removed from the whole test system; 5 — “Power” indicator (indicates that power is applied to the CS-3.1 Switchgear Module); 6 – voltage connectors (phases A, B, C, and neutral) 7 – connectors for currents ( $I_{A0}$ ,  $I_{B0}$ ,  $I_{C0}$ )

8 – connectors for currents ( $I^*_A$ ,  $I^*_B$ ,  $I^*_C$ )

The rear panel is shown in Fig. 2.2.

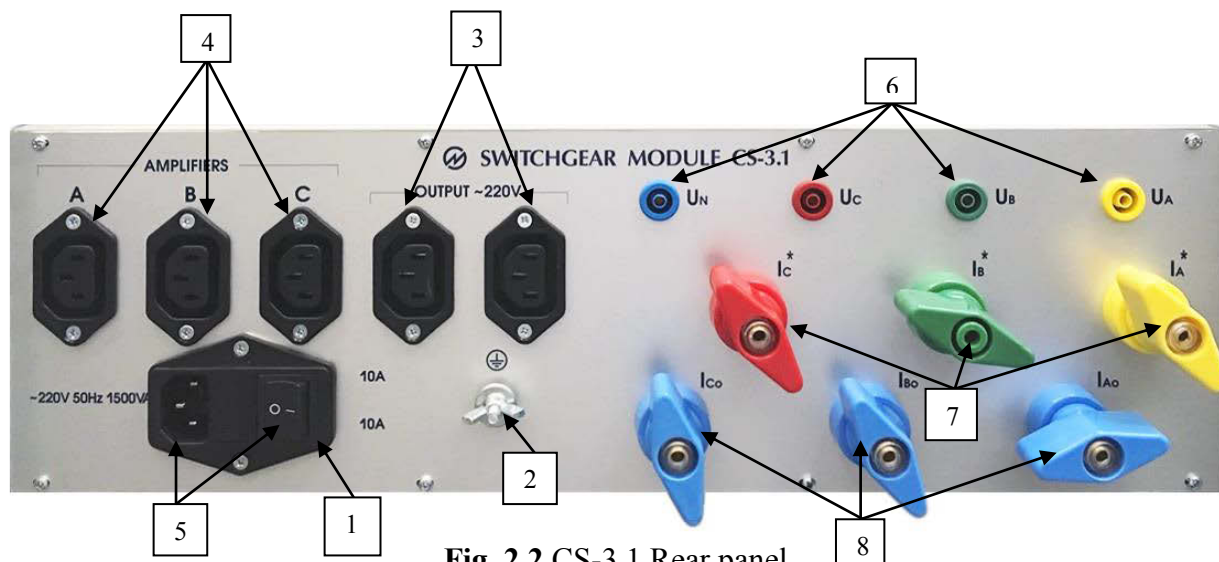
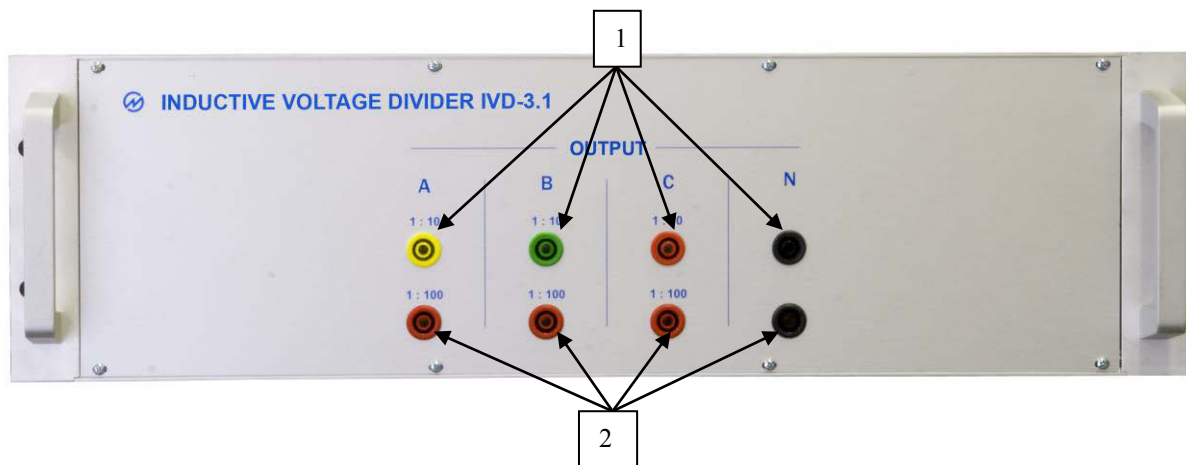

**Fig. 2.2** CS-3.1 Rear panel

1 — fuse holders; 2 — ground terminal; 3 — connectors for applying power to the Energoforma 3.1 generator and Energomonitor 3.1KM reference meter; 4 — connectors for applying power to the Current Amplifiers (phases A, B, C); 5 — power switch and connector for applying power to the whole test system; 6 – connectors for taking the output voltages of the test system (phases A, B, C, and neutral); 7 – connectors for taking the output currents of the test system ( $I^*_A$ ,  $I^*_B$ ,  $I^*_C$ ); 8 – connectors for taking the output currents of the test system ( $I_{A0}$ ,  $I_{B0}$ ,  $I_{C0}$ )

### 2.2.2 Inductive Voltage Divider IVD-3.1

IVD-3.1 is used to reduce the voltage taken from the voltage amplifier VA-3.1 by a division factor. The front panel is represented in Fig. 2.3.



**Fig. 2.3** IVD-3.1 front panel

1 — connectors for taking the output voltages of the divider 1/10 – phases A, B, C, and neutral;  
2 — connectors for taking the output voltages of the divider 1/100

The rear panel is shown in Fig. 2.4.

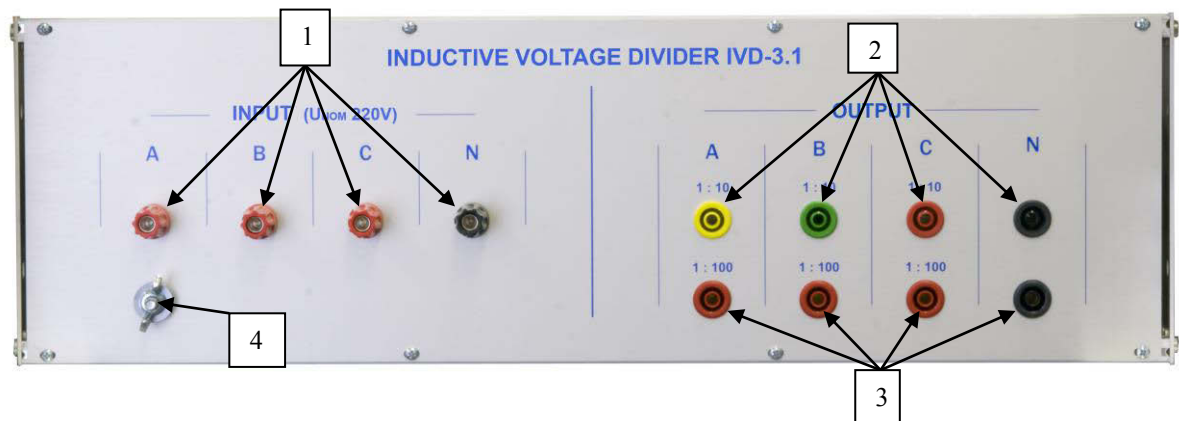

**Fig. 2.4** IVD-3.1 rear panel

1 — input voltage connectors (up to 300V) - phases A, B, C, and neutral; 2 — connectors for taking the output voltages of the divider 1/10 – phases A, B, C, and neutral; 3 — connectors for taking the output voltages of the divider 1/100;  
4 — ground terminal

**Note!** The output connectors located on the front and rear panels are connected in parallel (duplicated).



### 2.2.3 Waveform Generator Energoforma 3.1

The front panel is pictured below.

Section 4.2 of the present manual describes operation of the Energoforma 3.1 in the manual mode.

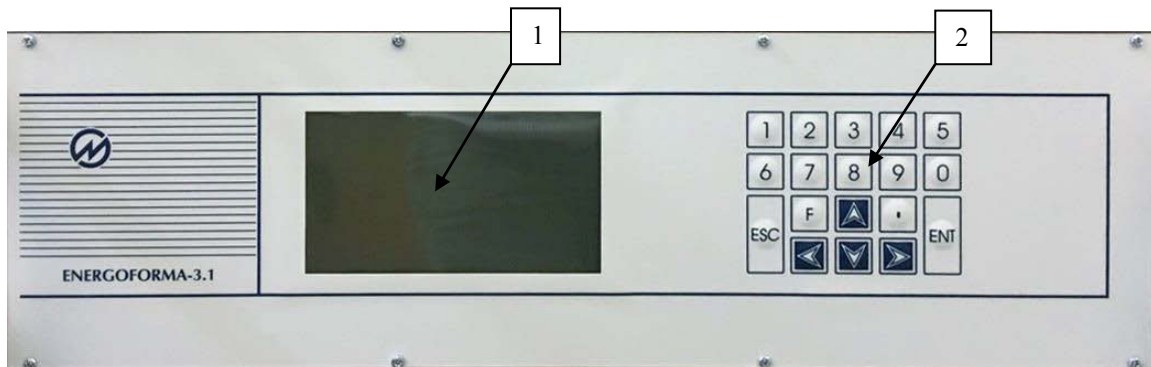

**Fig. 2.5** Energoforma 3.1 front panel  
1 — graphic display; 2 — keypad

The rear panel is shown in Fig. 2.6.

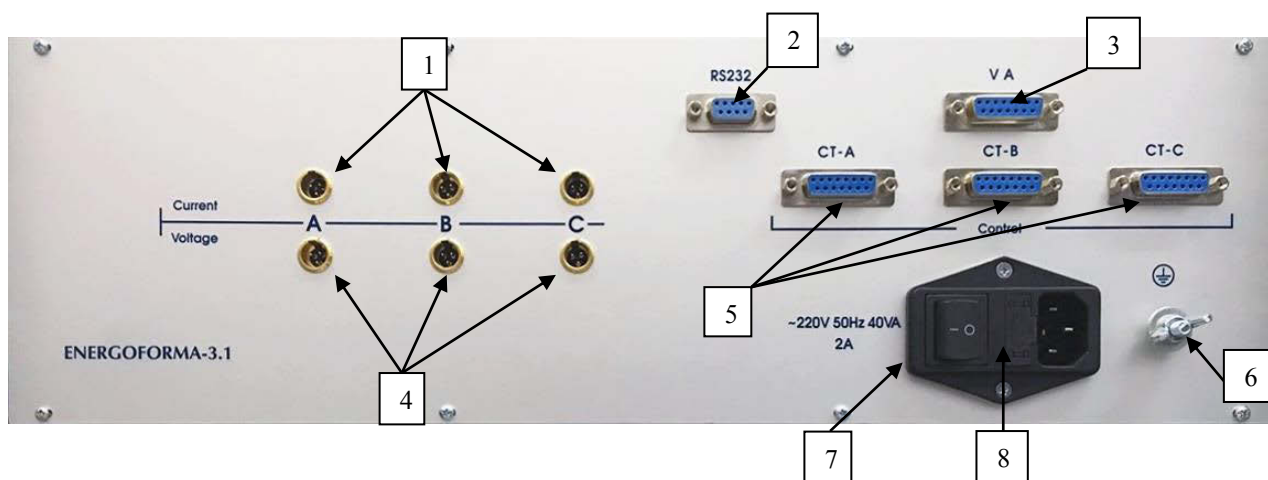
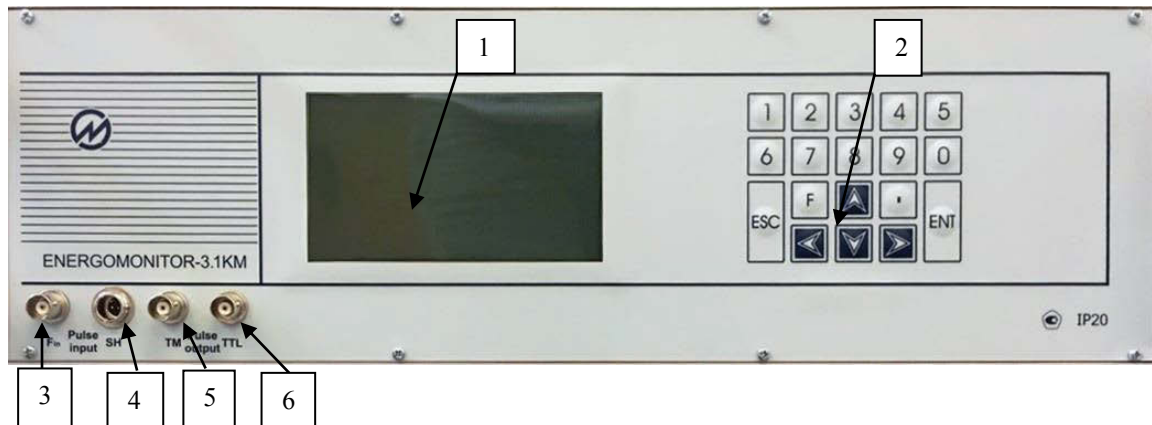

**Fig. 2.6** Energoforma 3.1 rear panel

1 — connectors for applying current output waveforms to the amplifiers; 2 — RS-232 connector; 3 — control bus connector (for transferring control signals to the voltage amplifiers); 4 — connectors for applying voltage output waveforms to the amplifiers; 5 — control bus connectors (for transferring control signals to the current amplifiers); 6 — ground terminal; 7 — fuse holders; 8 — power switch and connector

## 2.2.4 Reference standard Energomonitor 3.1KM

The front panel is shown in Fig. 2.7.



**Fig. 2.7** Energomonitor 3.1KM front panel

1 — graphic display; 2 — keypad; 3 — socket for connecting devices under test with an active pulse output (3-15V); 4 — socket for connecting a scanning head (SH); 5 — pulse output connector (for taking a frequency signal proportional to the measured power) (5V); 6 — pulse output connector (24V)

The rear panel is shown in Fig. 2.8.

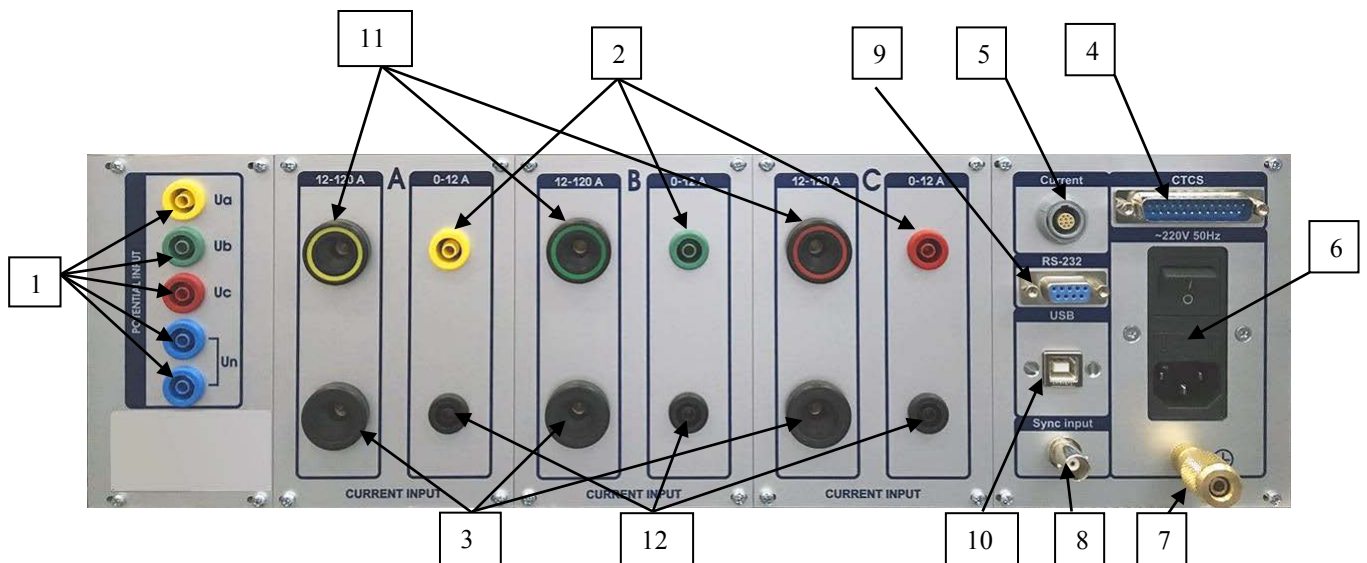
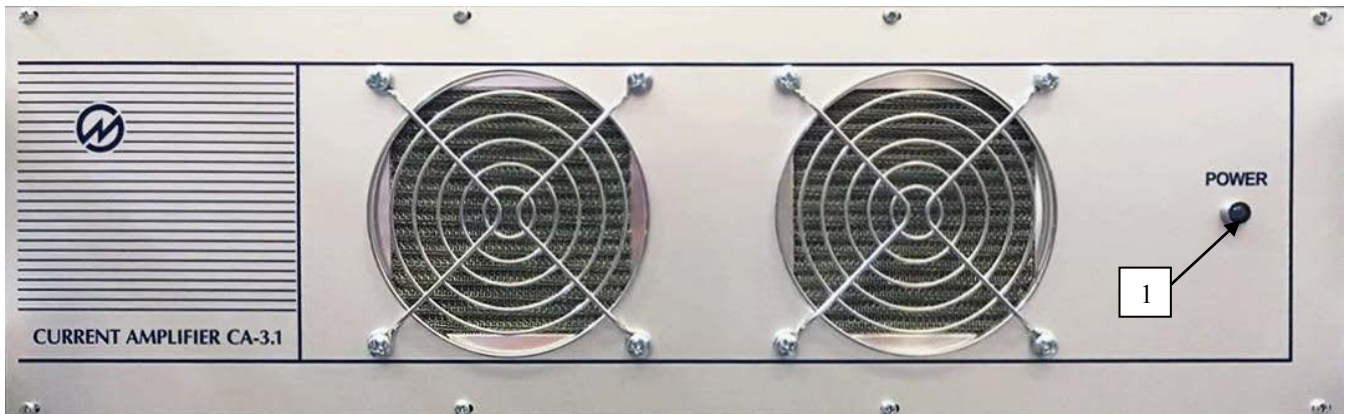

**Fig. 2.8** Energomonitor 3.1KM rear panel

1 — input connectors for applying measured voltages (phases A, B, C, and neutral N)  
 2 — input connectors for applying measured currents up to 11A  
 3 — output connectors for the currents over 11A  
 4 — control bus connector (for controlling CTCS – Current Trans. Calibration Switch)  
 5 — connector for connecting CTCS current circuits or contactless current sensors  
 6 — power switch and connector  
 7 — ground terminal  
 8 — connector for the Time Correction Module  
 9 — RS-232 connector  
 10 — USB connector  
 11 — input connectors for applying measured currents over 11A  
 12 — output connectors for the currents up to 11A

## 2.2.5 Current Amplifier CA-3.1

The front panel is shown in Fig. 2.9.



**Fig. 2.9** CA-3.1 front panel  
1 — Power indicator

The rear panel is represented in Fig. 2.10.

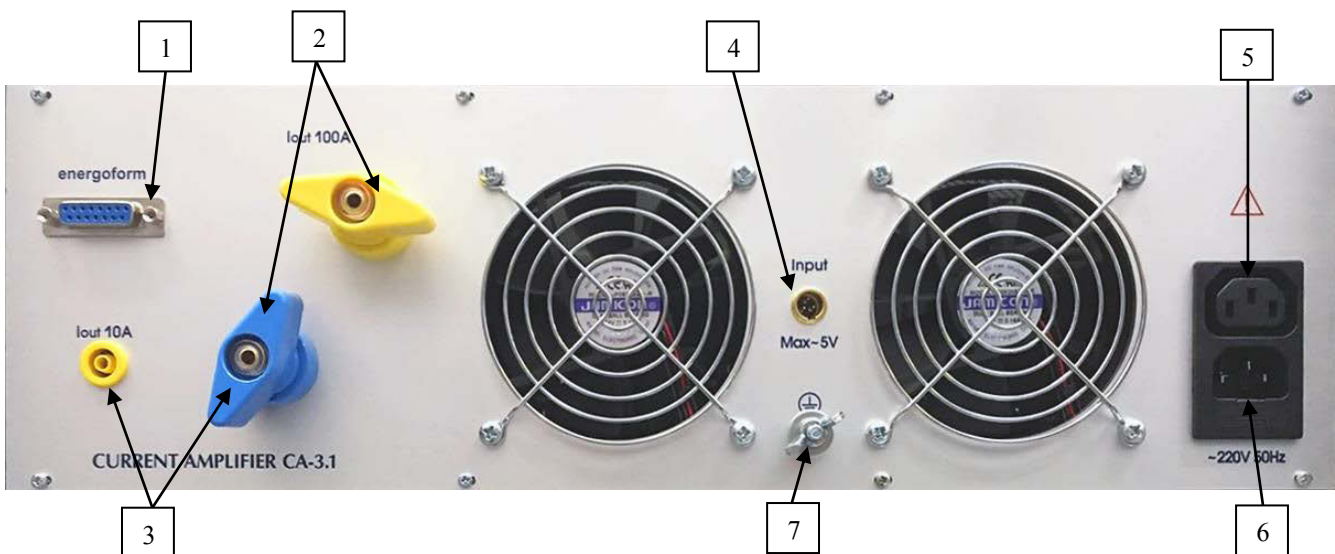
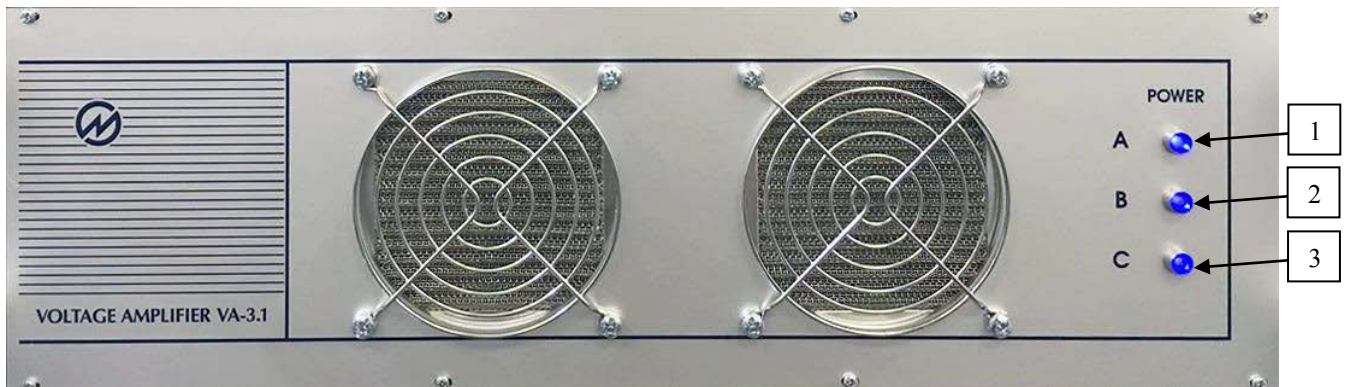

**Fig. 2.10** CA-3.1 rear panel (for the version up to 100A)

1 — control bus connector (for controlling the Energoforma 3.1 generator); 2 — output connectors for currents over 11A; 3 — output connectors for currents up to 11A; 4 — input connector for current (5V max); 5 — input power supply connector; 6 — power supply connector for the Voltage Amplifier VA-3.1; 7 — ground terminal

### 2.2.6 Voltage Amplifier VA-3.1

The front panel is pictured in Fig. 2.11.



**Fig. 2.11** VA-3.1 front panel  
1,2,3 — power indicators for phases A, B, and C.

The rear panel is pictured in Fig. 2.12.

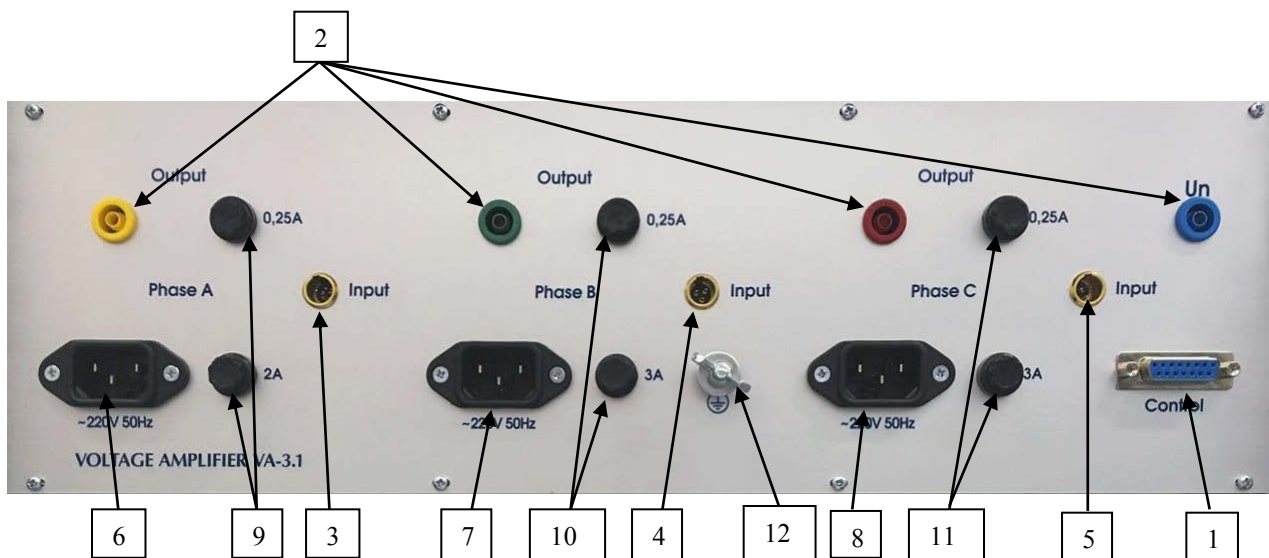
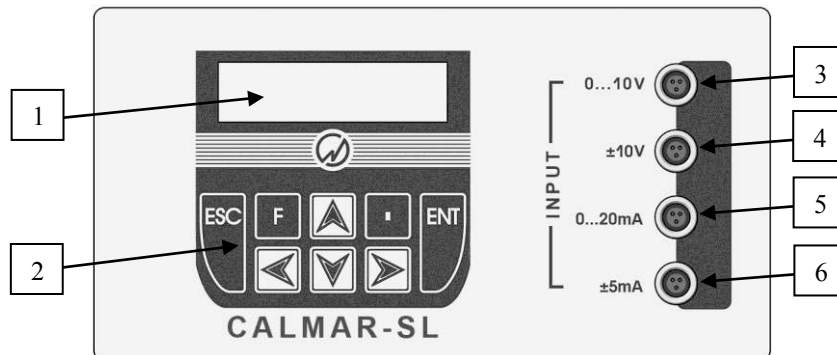

**Fig. 2.12** VA-3.1 rear panel

- 1 — control bus connector (for controlling the Energoforma 3.1 generator)
- 2 — terminals for output phase voltages and neutral voltage
- 3 — connector for the input voltage ( $U_{MAX} - 5V$ ), phase A
- 4 — connector for the input voltage ( $U_{MAX} - 5V$ ), phase B
- 5 — connector for the input voltage ( $U_{MAX} - 5V$ ), phase C
- 6 — power supply connector, phase A
- 7 — power supply connector, phase B
- 8 — power supply connector, phase C
- 9 — fuse holders, phase A
- 10 — fuse holders, phase B
- 11 — fuse holders, phase C
- 12 — ground terminal

## 2.2.7 Error Calculation Unit Calmar-SL

Calmar-SL is a DC Current/Voltage-to-Frequency Converter designed to measure instantaneous values of DC voltage and DC current signals and to convert them into proportional frequency signals. In the test system, the Calmar-S is used as an error calculation unit for the PC-controlled (automatic) mode. The front panel is pictured in Fig. 2.13.



**Fig. 2.13** Calmar-SL front panel

1 — alpha-numeric display; 2 — keypad; 3 — Unipolar voltage input (for voltage converters with output ranges 0...5V and 0...10V); 4 — Bipolar voltage input (for voltage converters with output ranges -5...+5V and -10...+10V); 5 — unipolar current input (for current converters with output ranges 0...20mA and 4...20mA); 6 — bipolar current input (for current converters with output ranges 0...+5mA and -5...+5mA)

The upper panel is shown in Fig. 2.14.

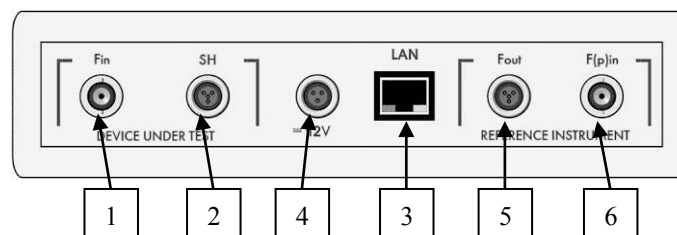

**Fig.2.14** Calmar-SL upper panel

1 — socket for connecting to the frequency output of the device under test (an energy meter); 2 — socket for connecting to a scanning head; 3 — Ethernet port; 4 — power supply connector; 5 — socket for connecting to the frequency input of the reference instrument (Energomonitor); 6 — socket for connecting to the frequency output of the reference instrument (Energomonitor)

## 2.2.8 Calibrated Coils

Calibrated Coils may be included in the test system for testing the instruments measuring current via contactless current sensors (Clip-on CTs, Rogowsky coils etc.).

The Calibrated Coils multiply the test current generated by the test system by a factor dependent on the number of turns (10, 20, 100, 200, or 300) so that the sensors measure the equivalent current of up to 100, 200, 1000, 2000, and 3000A flowing through the coils.





**Fig. 2.15** 20-Turn Calibrated Coils



**Fig. 2.16** 100-Turn Calibrated Coils

## 2.2.9 DC Power Supply

### 2.2.9.1 Description

AKIP-1133-XXXX (originally, a DC Power Supply of DSP-HR Series produced by IDRC) is a programmable DC Power Supply that provides a DC power signal of up to 750W. An output DC voltage signal is set in 1mV increments, and an output DC current signal – in 1mA increments. The AKIP-1133-XXXX corresponds to the DSP-HR instrument (1UH 750W version), see the DSP-HR Series User Manual).

The model name on the upper panel nameplate represents the basic characteristics of the model:

Model	Type	Output voltage	Output current
AKIP-1133-6-100	DC current source	0V...6V	0A...100A
AKIP-1133-300-2.5	DC voltage source	0V...300V	0A...2.5A

The front panel of the DC Power Supply is represented in Fig. 2.17a and 2.17b.

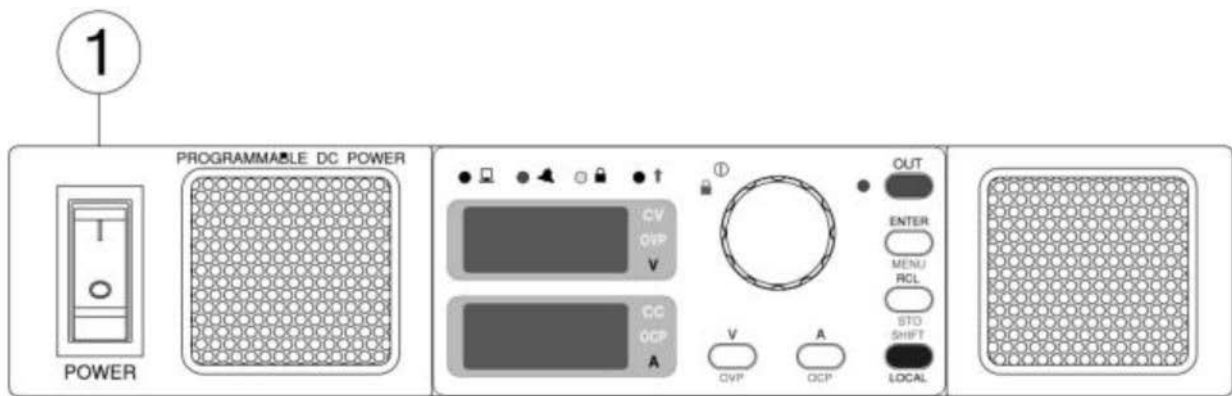

**Fig. 2.17a** DC Power Supply front panel

1 – Power switch

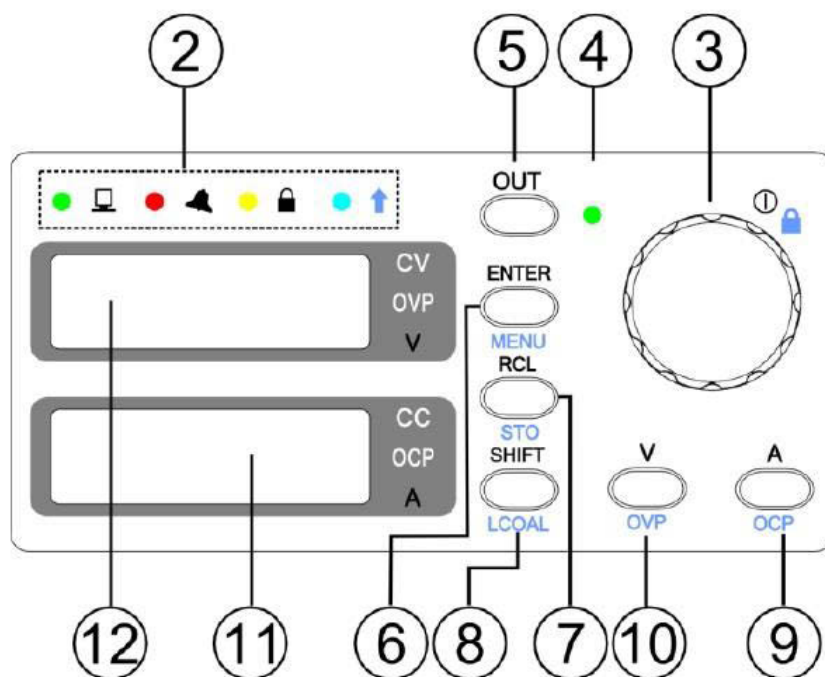

**Fig. 2.17b** Front panel controls and indicators

- 2 – Operation status indicators
- 3 – Rotary Encoder
- 4 – Output ON/OFF indicator
- 5 – Output ON/OFF control key
- 6 – ENTER/MENU key
- 7 – RCL/STO key
- 8 – SHIFT/LOCAL key
- 9 – A set/OCP key
- 10 – V set/OVP key
- 11 – Current display
- 12 – Voltage display

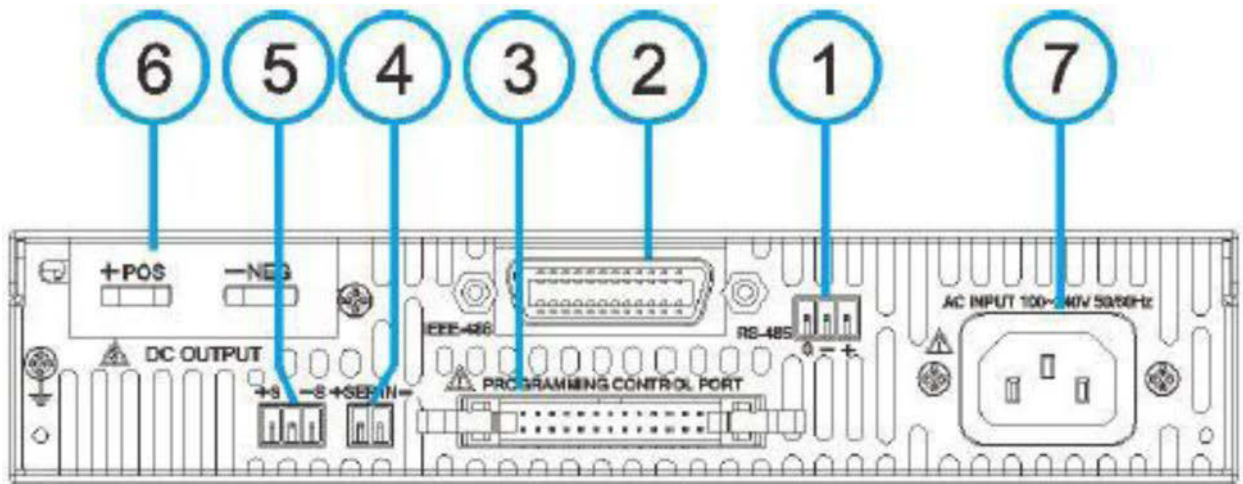

Fig. 2.18a AKIP -1133-6-100 Rear panel

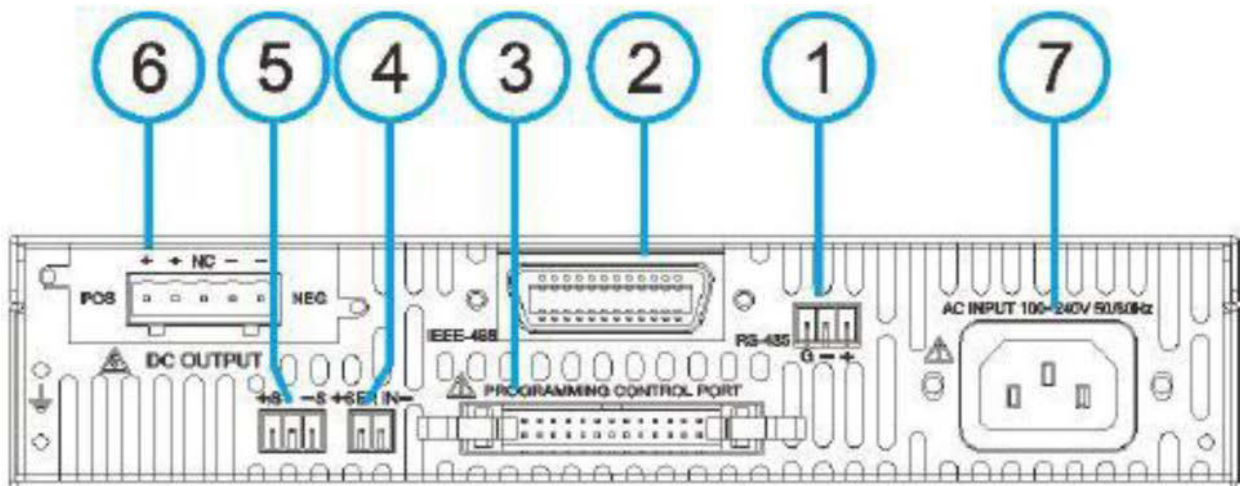

Fig. 2.18b AKIP -1133-300-2.5 Rear panel





- 1 – 3-pin terminal block for RS-485 interface connection
- 2 – GRIB connector (IEEE-488)
- 3 – Analogue programming port (used for connecting DC Power Supplies in series and in parallel)
- 4 - Connector used to synchronize output voltage signals of 2 units (Master and Slave DC Power Supplies) operated in series
- 5 – Remote Sense/Compensation terminal (used to measure the voltage on the load side; make sure that the correct polarity is provided – otherwise the DC Power Supply **may be damaged!**)
- 6 – DC output terminals
- 7 – AC input terminal block (AC power supply)

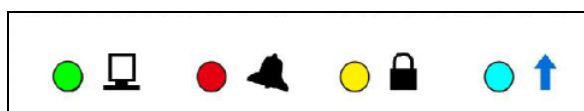

## Description of controls and indicators on the front panel

### 2 – Operation status indicators



 Remote	REMOTE indicator (lights when the remote control is activated; press the LOCAL key to disable the remote control)
 Alarm	ALARM indicator (lights when there is a command error, manual operation error, or power unit failure, see the DSP-HR series User Manual, Chapter 11, “Error codes”)
 Keylock	KEYLOCK indicator (lights when the keylock mode is activated; press SHIFT+Encoder to enable/ disable the mode)
 Shift	SHIFT indicator (lights when the shift key is pressed)

### 3 – Rotary encoder

The Rotary encoder is used to adjust the output current/voltage value by turning it clockwise (to increase the value) or counterclockwise (to decrease it). To change the digit position to be adjusted, press the encoder, adjust the digit and press ENTER to confirm.

Pressing SHIFT+Encoder enables/disables the Keylock mode.

### 4 – Output ON/OFF indicator

The indicator lights when the output is ON.

### 5 – Output ON/OFF control key

The output will be disabled automatically in the following cases:

a) In the DC Power Supply settings, the automatic cut off has been set for the following situations:

- Restart of the DC Power Supply
- Interruption of the mains supply for more than 100 ms
- Mains supply parameters exceed their permissible ranges for more than 500 ms

b) On activating the OCP (overcurrent), OVP (overvoltage), or OTP (over-temperature) protection circuits

c) When the user is working with the front panel menu

### 6 – ENTER/MENU key

- Press to confirm the set value
- Press SHIFT+ENTER to get access to the menu functions (**when the output is ON, the menu is inaccessible; from the other hand, if the menu is active, the output will be turned OFF**)

### 7 – RCL/STO key

(Maximum 16 settings can be stored / recalled from the memory)

- Press RCL to recall the stored voltage/current settings from the memory
- Press SHIFT+STO to record the set value into the memory
- Press the V key to leave the RCL mode

### 8 – SHIFT/LOCAL key

In the manual mode, the key is pressed to activate the second (coloured blue) function ( indicator lights up in this case). If the DC Power Supply works in the remote control mode, the only key you can press is LOCAL (which sets the DC Power Supply to the manual mode).

#### 9 – A /OCP key

- Sets the output current: when the key is pressed, the last digit on the indicator will be blinking; adjust the digit by turning the encoder, press ENTER to confirm, and press the encoder to change the digit position
- Sets the overcurrent value (SHIFT+OCP): the setting is adjusted in the same way

#### 10 – V/OVP key

- Sets the output voltage: when the key is pressed, the last digit on the indicator will be blinking; adjust the digit by turning the encoder, press ENTER to confirm, and press the encoder to change the digit position
- Sets the overvoltage value (SHIFT+OVP): the setting is adjusted in the same way
- In the Recall mode, the key is pressed to leave the mode

#### 11 – Current display (5 digits)

The indicators on the right side:

CC – Constant Current indicator (lights when the DC output constantly produces DC current)

OCP – Overcurrent protection indicator (lights when the OCP is active, i.e. when the output current is over 110% of the set OCP value or the OCP value is exceeded for more than 1s ; blinks when the OCP is being adjusted)

A – Amperes

#### 12 – Voltage display (5 digits)

The indicators on the right side:

CV – Constant Voltage indicator (lights when the DC output constantly produces DC voltage)

OVP – Overvoltage protection indicator (lights when the OVP is active; blinks when the OVP is being adjusted)

V – Volts

### 2.2.9.2 Operation

Refer to Chapters 7, 8, 9, 11, 12 of the DSP-HR series User Manual (1UH 750W version of the DC Power Supply).

## 2.3 Design and operation

The test system is supplied as a calibrator's workstation. It operates using the comparison principle, namely it compares the readings taken from the reference instrument Energomonitor 3.1KM (EM3.1KM) against that from the instrument under test.

The Phantom Power Source Energoforma 3.1 (EF 3.1), voltage amplifier VA 3.1 and current amplifiers CA 3.1 operate together as a test signal source. All modules of the test system are connected via the Switchgear Unit CS 3.1.

The EF 3.1 generator is used to digitally specify current and voltage test signals, which are applied to the current and voltage amplifiers. The operating ranges of the amplifiers are controlled by the EF 3.1 via the control bus.

The Switchgear Unit CS-3.1 provides power supply to the EF 3.1, EM 3.1KM, current / voltage amplifiers, and devices under test. The test signals taken from the amplifiers are applied to the reference instrument and to the devices under test. The devices under test with pulse inputs and outputs are connected to the special connectors on the front panel of the EM 3.1KM.

### 2.3.1 Reference standard Energomonitor 3.1KM

As a multipurpose reference standard meter, the EM3.1KM can be used for verification, calibration and accuracy testing of various reference-class and service class instruments. Refer to the “Multifunctional Reference Standard Energomonitor 3.1KM User’s Manual” (MC3.055.026UM) for the description of its operation in detail.

### 2.3.2 Three-phase Programmable Waveform Generator Energoforma 3.1

As a programmable waveform generator the EF 3.1 produces a single- or three-phase system of currents and voltages in accordance with a user-specified digital model.

The block diagram of the EF3.1 is shown in Fig. below.

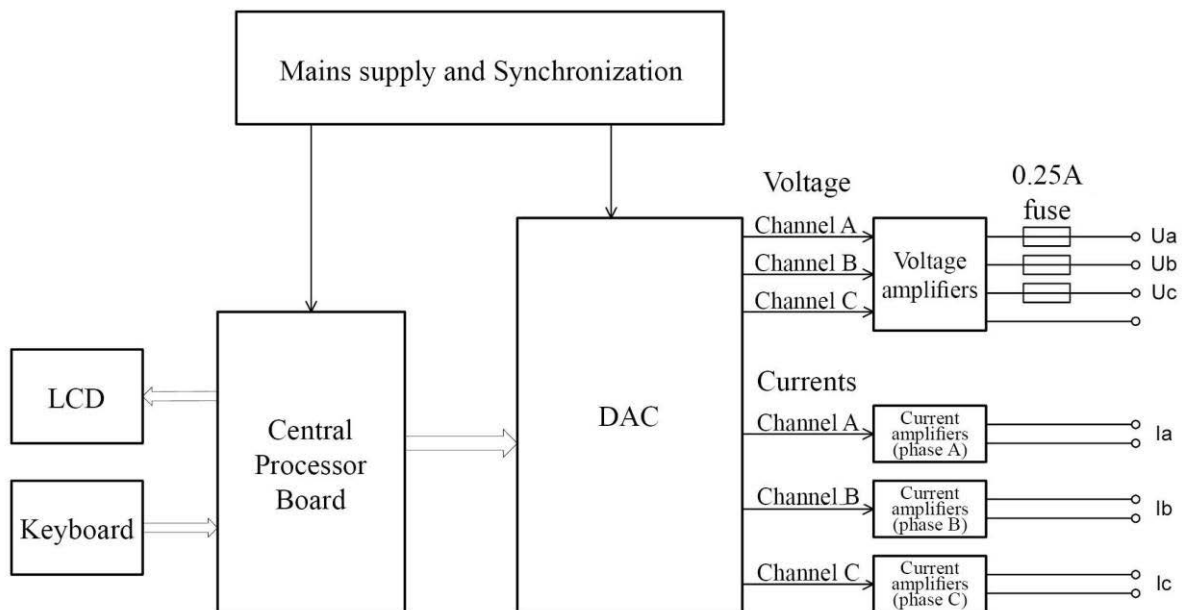

The generator is based on a digital-to-analog conversion (DAC) principle. The DAC board has 6 identical channels that independently convert 16-bit binary input signals into analog form (3 voltages and 3 currents).

The Central Processor board exercises full control over the Generator. It produces the arrays of samples representing each of the six waveforms point by point. The data arrays are fed into the DAC board and converted into 3 current and 3 voltage curves. Conversion results are stored in the non-volatile memory and can be displayed on the LCD screen.

The Central Processor board:

- Keeps time and marks intervals as per real-time clock
- Supports data exchange with external devices
- Receives data and commands from the operator’s keyboard

The keypad is mounted on the front panel and connected to the Central Processor board. The keypad is used to specify how the information should be displayed, to enter the parameters of signals to be generated (waveform, amplitude, phase shifts for currents and voltages) etc.

The Power Supply unit generates voltages for the Central Processor Board. It also contains a synch circuit that keeps output signals synchronized with a power supply network.

### 2.3.3 Current Amplifier CA-3.1

Three identical CA-3.1 modules are installed into the test system rack, one for each channel (A, B, and C).

The analog current signals of the required shape and value taken from the outputs of the EF 3.1 generator come to the inputs of the amplifiers related to phases A, B, and C. The amplifiers swap their

operation ranges following the commands issued by the EF 3.1 and transmitted over its control bus.

Power (~220V) is fed from the Switchgear module CS-3.1, and then transferred to the voltage amplifier VA 3.1.

The nominal (rated) values of output currents and output current ranges of the CA-3.1 are given in Table 2.1.

*Table 2.1*

<b>Output current ranges, A</b>	<b>Nominal (rated) currents, A</b>
10.02001–110.0	100
2.00401–10.99999	10
0.50101–2.19999	2.0
0.00001–0.54999	0.5

### **2.3.4 Voltage Amplifier VA-3.1**

Just one rack-mounted VA-3.1 houses three independent voltage amplifiers, one for each channel (A, B, and C).

The analog voltage signals of the required shape and value taken from the outputs of the EF 3.1 generator come to the A, B, and C inputs of the amplifier.

The amplifier swaps its operation ranges following the commands issued by the EF 3.1 and transmitted over its control bus.

The module is powered (~220V) from the Switchgear unit CS-3.1.

The nominal (rated) values of output voltages and output voltage ranges of the VA-3.1 are given in table 2.2.

*Table 2.2*

<b>Output voltage ranges, V</b>	<b>Nominal (rated) voltages, V</b>
220.441–528.0	480
60.121–242.0	220
0.001–65.999	60

### **2.3.5 DC Power Supply**

Two DC Power Supply modules are supplied as part of the test system (one provides DC current, and the other – DC voltage). Refer to section 2.2.9 of the present manual and to the DSP-HR Series User Manual for its controls, connectors and operating modes.

The modules are powered from mains (~220V).

### **2.3.6 Switchgear module CS-3.1**

CS-3.1 provides power (~220V) to the test system modules (EM3.1KM, EF3.1, voltage and current amplifiers). Refer to section 2.2.1 of the present manual for connector orientation.

### **2.3.7 Error calculation unit Calmar-SL**

Calmar-SL is a DC Current/Voltage-to-Frequency Converter designed to:

- Convert output signals coming from measuring voltage / current / power / phase / frequency converters into proportional frequency signals provided that these output signals are generated in the form of DC voltage or DC current
- Determine measuring errors of electrical energy meters with pulse output using a comparison method (by comparing frequency signals taken from the reference meter and meter under test)

Refer to the Calmar-S User Manual (document MC2.725.001 UM).

### 2.3.8 Calibrated Coils

Calibrated Coils are designed to test the instruments measuring current via contactless current sensors (Clip-on CTs, Rogowsky coils etc.).

The Calibrated Coils multiply the test current generated by the test system by a factor dependent on the number of turns (10, 20, 100, 200, or 300) so that the sensors measure the equivalent current of up to 100, 200, 1000, 2000, and 3000A flowing through the coils.

#### How to use:

Connect the “Source” terminals of the Calibrated Coils (coloured red or yellow/green/red) to the “low current” terminals  $I_{a^*}$ ,  $I_{b^*}$ ,  $I_{c^*}$  of the Switchgear Unit. Connect the “Load” terminals of the Calibrated Coils (coloured black or blue) to the “low current” “common” terminals  $I_{AO}$ ,  $I_{BO}$ ,  $I_{CO}$  of the Switchgear Unit. Clamp the current sensors to be tested around the current carrying conductor of the Coils considering that the arrows ( $\rightarrow A$ ,  $\rightarrow B$ ,  $\rightarrow C$ ) pictured on the Calibrated Coils show the current flow direction and the (S  $\rightarrow$  L) arrows stand for Source-to-Load direction. A connection example is given in the figure below.



**Note! The current going through the Calibrated Coils from the CA-3.1 amplifier shall not exceed 10A.**

The indication of current, power and energy read by the instrument under test with contactless current sensors will be  $n$  times greater than the indication of the EM3.1KM reference instrument, where  $n$  is the number of Calibrated Coil turns.

### 2.3.9 Inductive voltage divider

IVD-3.1 is used to expand the operating range of the test signal source down 10V by reducing the voltage taken from the voltage amplifier VA-3.1 by a division factor.

Basic characteristics of the divider:

- Max input voltage: 220V
- Modular error: <0.2%
- Angle error: <1°

## 3 PREPARING FOR OPERATION

### 3.1 Notes on operating conditions

**Caution!** If the test system has been moved from a cold environment (with ambient temperature below minus 20° C) into a warm one, it shall be left to stand for at least 4 hours at room temperature before applying power, to make sure that no condensation remains inside.

**Warning!** The test system shall not be used under the ingress of moisture inside its body.

**Caution!** Do not energize the current amplifiers CA-3.1 when their current circuits are opened or unloaded (the current circuits must be closed in a loop via a device under test or Calibrated Coils or jumpers).

### 3.2 Turning on

**Caution!** To avoid electric shock, it is strongly recommended to connect (disconnect) the device under test to the test system when the system is de-energized. Connection (disconnection) shall be carried out by qualified service personnel in compliance with local safety regulations in force.

The test system has four terminals for connecting phase voltage circuits (Ua, Ub, Uc, Un) and six terminals for connecting phase current circuits (Ia, Ib, Ic, Ia\*, Ib\*, Ic\*, each galvanically isolated from others). All terminals are placed on the Switchgear Unit. The voltage circuits are made symmetrical with the “neutral” as a common point.

**Note!** Use manufacturer-supplied cables only. Inspect the cables. Ensure all joints are made properly to avoid overheating and excessively high resistance.

Insert 6 mm plugs into sockets **until they click into place** (pull the plug to check that it is properly fixed).

To turn on the test system, proceed as follows:

- Complete all power and signal connections between rack-mounted units in accordance with the diagrams given in Appendix A.
- Press the ON button on the front panel of the Switchgear Unit to apply power to the Energoforma 3.1, Energomonitor 3.1KM and amplifiers.
- Press the Phase A, Phase B, and Phase C buttons on the CS-3.1 front panel to apply power to the current and voltage amplifiers.

When powered up, both the Energoforma 3.1 and Energomonitor 3.1KM automatically start their self-test and initialization procedures. When initialized, the EM3.1KM shows its welcome screen and the EF3.1 shows its main menu.

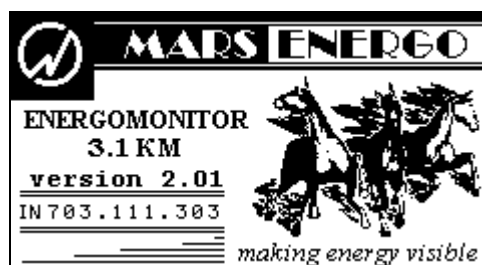

Fig. 3.1 EM3.1KM welcome screen

## 4 OPERATION

The test system is operated in 2 modes:

- PC-controlled mode (with one of the programs from the Energoforma software package)
- Standalone mode (manually controlled from the keypads of the EM3.1KM and EF3.1 instruments)

### 4.1 PC-controlled operation

The PC-controlled mode is accessible with one of the programs from the Energoforma software package installed on the user PC. The programs work under OS MS Windows 2000, XP, Vista, Windows 7 (32-bit or 64-bit architecture).

Recommended PC configuration:

- Processor Pentium III 700 MHz or more powerful
- At least 256 MB RAM
- At least 3 MB of disc space for installation and 20 MB of additional space for the Microsoft .NET Framework package, version 4.0 (if not installed on your computer)
- Video adapter supporting 1024x768 resolution
- Display 15" (or more)
- Mouse
- Two free COM ports (via 2 RS-232 ports or USB/2 RS232 adapter or Ethernet-адаптер)
- One more COM port (for the Environment Monitor, if applicable)
- Ethernet router (for connecting 3 Calmar-SL units to your PC).

**Caution!** To run the software correctly under Windows Vista or Windows 7 it is necessary to turn off the **User Account Control** option (UAC). Refer to the UAC disabling procedure in the Appendix of the corresponding User's Manual (EnfCalibrationRig).

Refer to the EnfCalibrationRig program user manual for operation of the test system in the PC-controlled mode under this software.

Proper communication links should be made before:

- Connect the EM 3.1KM reference meter to one of the serial ports of your computer and the EF3.1 generator to another one
- In the EM3.1KM menu, enable the Data Exchange with PC mode, select a communications port, then select data exchange rate for RS-232 connection (refer to the Energomonitor 3.1KM User's Manual)
- As regards the EF3.1 generator, it goes to the PC-controlled mode automatically as soon as it is connected to a PC, and the EnfCalibrationRig program is launched (refer to the Energoforma 3.1 User's Manual).

### 4.2 Operation in stand-alone mode

In the stand-alone mode, the test system is operated via the keypads of the reference meter (EM3.1KM), DC Power Supply (refer to the corresponding user manuals for the operational information) and waveform generator (Energoforma 3.1).

Operation of the Energoforma 3.1 waveform generator is described below.

#### 4.2.1 Energoforma 3.1 - operator interface

Energoforma 3.1 controls and connectors are represented in Fig. 2.5 and 2.6.

The operator interface of the Energoforma 3.1 (the generator below) includes a graphical LCD (240x128) and 18-button membrane keypad. The interface makes it possible to select operation modes and configure the parameters of generated current and voltage waveforms. Table 4.1 describes the keys located on the front panel.

Table 4.1

Key	Name and Function
0, ..., 9	Numeric keypad: use to enter numeric values
□	- Decimal point: press before entering the desired magnitude of a fractional part; - Press to enter a negative value before specifying its magnitude
▲, ▼	- Up and down arrow keys: press to scroll through various menu items and setup fields
◀, ▶	- Left and right arrow keys: press to increment/decrement the value of an active field - Press to move along the status line fields when it is active
ENT	- Enter: Press to activate a menu item or status line field - Press to save changes
ESC	- Press to return to an upper-level menu without saving changes - Press to leave the status line
F	- Press to activate the status line

As it is turned on, the generator carries out self-test procedure. At the conclusion, the main menu will be displayed (Fig. 4.1).



Fig. 4.1 Main menu

The basic menu navigation principles are given in Table 4.1.

**Notes on using the keypad:**

- Each window has one or more setup fields in it. When there are several fields in the window, ▲, ▼ keys can be used to skip from field to field. The menu item currently active is highlighted by inversion
- When using the keypad to specify the parameters in the setup windows, observe the following rules:
  - 1) Key ▶ increases and key ◀ decreases, respectively, the value of an active field. The longer the key remains depressed, the faster the active field changes its value within its permissible range. Values of some fields (e.g., “phase shift”) are changed cyclically.
  - 2) By pressing number keys 0 to 9 you can immediately type in the desired value within the permissible interval.
  - 3) To enter the fractional part of a number, press □ (decimal point) after entering its integer part.
  - 4) To enter a negative number, press □ (decimal point) key first (!), BEFORE specifying the desired magnitude (provided that permissible values of the parameter may be negative). As soon as the decimal point key is pressed, the field assumes a negative value with the smallest possible magnitude (i.e. “-1” for integer fields, “-0.01” for the fields specified in 1/100 increments, etc). Then modify the field (as described in previous paragraphs) to set a target value in it.



- After pressing ENT, you will see  (a “sand glass” icon) in the status line. This means that the recalculation is in progress, and further operation is suspended till the end of the process.



An upper-level menu can be accessed with “ESC” key.

**Note:** The operator interface may be modified with respect to the order of displaying information. The changes do not affect the accuracy and technical characteristics of the generator.

#### 4.2.2. Energoforma 3.1 - Status line and basic modes of operation

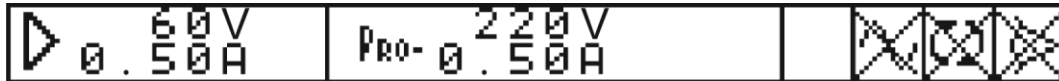
Regardless of an active screen, the bottom part of the display is always occupied by the status line informing the operator on the basic modes currently in force.



The leftmost part (marked  $\triangleright$ ) shows nominal values of sub-ranges currently activated in the current and voltage amplifiers. The central part (marked “PRO” = programmed) indicates nominal values of the sub-ranges that will be enabled on starting generation of newly specified voltage and current waveforms. As soon as the “generation”  or “regeneration”  command is enabled, the currently active nominal values become equal to the “programmed” values.

The meaning of each icon is described below (from right to left)

**Fig. 4.2** Status line



The status line stands in two states: active and inactive. When it is inactive, it just displays status information. When it is active, the user can change basic operation modes. The keys  $\leftarrow$ ,  $\rightarrow$  are used to scroll through the active status line and select a field in it (while selected, the field is highlighted).



**The status line is activated from any screen by pressing the F key and deactivated by pressing ESC.**

The meaning of each icon is described below (from right to left).







#### **Basic modes of operation**

*“Generation” mode:*

- When  is active, output waveforms (with currently active settings) are being generated on the outputs of the Generator.
- When  is active, generation of output waveforms is turned off, and the outputs have zero potentials.

**Note!** To switch between  and  modes, activate the status line with the F key, select the corresponding icon and press “ENT”.



*“Regeneration” mode (accessible only when  icon is active):*

-  — “regeneration” mode (generation of new signals with newly modified settings);  
Activate  icon (select it and press ENT) each time you want to start generation of signals with newly specified settings. First of all, “Sand glass” icon  will appear to let you know that recalculation of the parameters is in progress, and further operation is suspended till this comes to the end. The Generator is ready to respond to further actions only when  icon disappears.
-  — is always displayed when the “generation” mode is off (.

*Mode of synchronization with mains frequency (accessible only when  icon is active):*

-  — mains synchronization mode is enabled, and the Generator monitors mains frequency and produces its output signals accordingly

-  — no monitoring of mains frequency is maintained at the moment. The Generator produces its output signals in accordance with the frequency specified by the “frequency” parameter (Fig. 4.8)
 

**Note!** To switch between  and  modes, activate the status line with ‘F’ key, select the corresponding icon and press “ENT”.

The “Sand glass” icon  (Fig. 4.3) informs you that recalculation of the parameters is in progress. Further operation is suspended till this comes to the end. Without the icon, the Generator is ready to respond to your further actions.

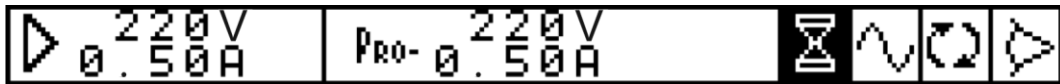

**Fig. 4.3** Status line  
(modification/recalculation in progress)

If an additional context-dependent function is included in the current menu/window, the name of this function appears on the active status line and gives access to that function (Fig. 4.4). Press ENT to enable the function.



**Fig. 4.4** Status line with one of additional functions in it

### 4.2.3 Energoforma 3.1 - “Standard signal” menu

In this mode, the Generator produces pure sine waveforms on its outputs. Angles between phase voltages are set to 120°.

You can use the window shown in Fig. 4.5 to specify:

- Fundamental (1st harmonic) frequency — from 42.50 to 70.00Hz in 0.01Hz steps;
- Phase shifts between currents and voltages for all phases — from -179.99° to +180.00° in 0.01° steps);
- Values of voltage — from 0 to 268V in 0.001V steps);
- Values of current— from 0 to 12A in 0.00001A steps).

The checkboxes  below I<sub>A</sub>, I<sub>B</sub>, I<sub>C</sub> are used to turn phase currents on/off as desired. To set any of phase currents to zero, select the corresponding switch with < and > and press ENT.

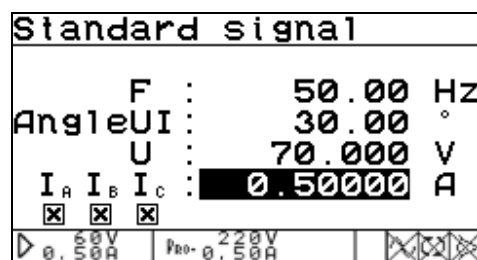

**Fig. 4.5** “Standard signal” setup window

New waveforms are recalculated on pressing ENT. It may take up to 5s to recalculate the parameters. The time of recalculation is determined by the selected wave shapes and the number of channels for which the parameters are recalculated. When recalculation is in progress, the status line displays  icon.

**Note:** All changes made in the “Standard signal” mode are automatically extended to the “Subharmonics” and “Phase Control” modes and vice versa.

#### 4.2.4. Energoforma 3.1 - “Special signals” menu

In this mode, user-defined signals are created. The RMS values and frequency of the 1<sup>st</sup> (fundamental) harmonic of output waveforms, phase shifts between output waveforms and harmonic composition of each waveform can be specified for each of six Generator’s channels individually.



Fig. 4.6 “Special signals” menu

The “Special signals” menu (Fig. 4.6) has six options:

- Programmed waveform;
- Subharmonics;
- Phase control;
- Dips and swells;
- Flicker;
- Library.



Fig. 4.6. “Specific signals” menu

##### 4.2.4.1. “Programmed waveform” menu

This option (Fig. 4.7) makes it possible to specify the signals to be generated to any desired values (within permissible limits):

- Frequency;
- Phase angles;
- Wave shape;
- RMS values of the 1<sup>st</sup> harmonics of output waveforms.

Additionally, the “Interharmonics” mode is turned on/off here.

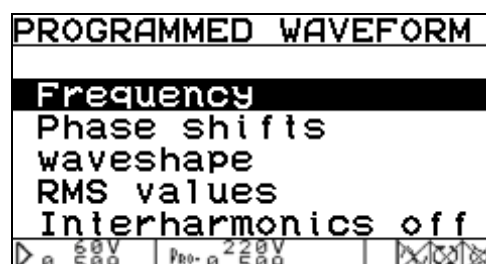

Fig. 4.7 “Programmed waveform” menu

### Setting frequency

In the “Frequency” window (Fig. 4.8) you can set fundamental frequency (i.e. frequency of the first harmonic) for the 3-phase system of voltage/current waveforms. This parameter **will be applied only if the mains synchronization mode is disabled** ().

When the synch mode is enabled () , the output frequency is determined by mains frequency. In other words, when the “eye” icon is active, the Generator ignores frequency specification entered in this window.

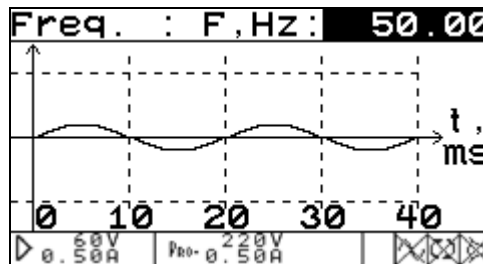

Fig. 4.8. “Signal frequency” setup window

“Frequency” is the only changeable field in this window. It can accept values of 42.50 to 70.00Hz specified in 0.01Hz increments. While the frequency is adjusted, the window displays its currently active value together with the associated waveform.

### Setting phase angles

In the “Phase shifts” window (Fig 4.9) you can set phase shifts between phase voltages and between currents and voltages of the same phase (by definition, phase angles between the channels are the angles between the respective first harmonics).

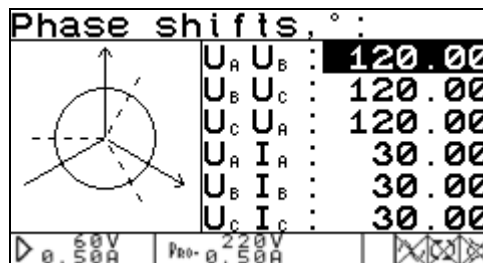

Fig. 4.9 “Phase angles” setup window

Six fields correspond to various angles (as applied to the first harmonics of signals to be generated) changeable within  $-179.99^\circ$  to  $+180.00^\circ$  in  $0.01^\circ$  increments. The values can be set by cycling through the range.

All settings currently selected are pictured on a vector diagram in the left part of the screen. Vectors on the diagram reflect each modification. Vectors currently selected for modification are displayed with arrows.

### Setting wave shapes

Screens representing wave shapes of desired signals may be of 4 types:

- Oscilloscope;
- Spectrum (linear);
- Spectrum (logarithmic);
- Phase shifts of harmonics.

The “Change view” field on the status line makes it possible to switch over the modes of representation (to change representation, activate the status line, select “Change view” and press ENT).

In the “Waveshape” window, you can set the desired signal shape in each of the 6 Generator’s channels. The required channel is selected in the corresponding field (“Ch.”) of the window.

### Oscilloscope

The “Oscilloscope” option (Fig. 4.10) displays the signal in the selected channel as a traditional oscillogram. The view of the oscillogram depends on whether the “Interharmonics” mode is turned on or off.

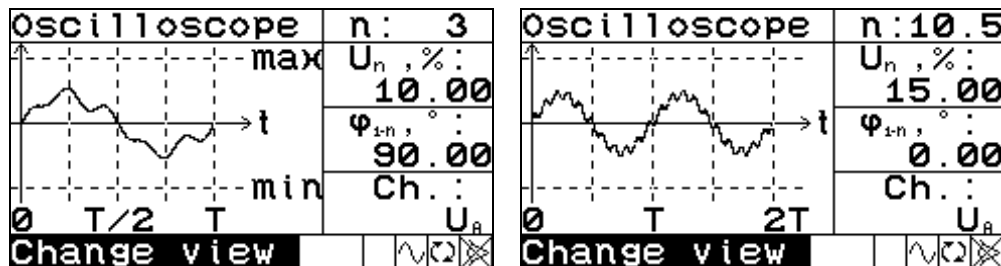

**Fig. 4.10.** “Waveshape” window in the form of oscillogram (left part — “Interharmonics” mode is off; right part — “Interharmonics” mode is on)

Four fields are available:

1) “**n**” – the number of the harmonic:

“Interharmonics” mode is off – selectable from the sequence: 1; 2; ... 49; 50

“Interharmonics” mode is on – selectable from the sequence: 0.5; 1; 1.5; 2; ..., 50; 50.5

The required value is selected with  $\leftarrow$ ,  $\rightarrow$  keys;

2) “**U<sub>n</sub>**” or “**I<sub>n</sub>**” – the amplitude ratio of the harmonic (% of the 1<sup>st</sup> harmonic):

“Interharmonics” mode is off – selectable within the range of 0 to 100.00 % in 0.01 % increments.

“Interharmonics” mode is on – selectable within the range of 0 to 15.00 % in 0.01 % increments.

3) “**φ<sub>1-n</sub>**” – the relative phase of the harmonic (phase shift of the selected harmonic with respect to the 1<sup>st</sup> harmonic; represented as a percentage of the 1<sup>st</sup> harmonic within the range of  $-179.99^\circ$  to  $180.00^\circ$  in  $0.01^\circ$  increments);

4) **Ch.** – the symbolic name of the channel (selectable from U<sub>a</sub> to I<sub>c</sub> channels; used to switch over 6 channels).

### Spectrum (linear)

The “Spectrum (linear)” option (Fig. 4.11) represents the spectrogram of a signal in the selected channel drawn in linear scale.

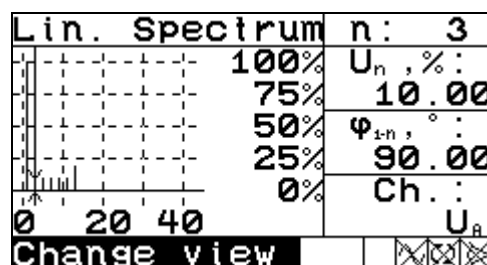

**Fig. 4.11.** “Waveshape” window with linear spectrum of amplitudes

**Spectrum (logarithmic)**

The “Spectrum (logarithmic)” option (Fig. 4.12) displays the spectrogram of a signal in the selected channel drawn in logarithmic scale (in decibels, dB). This only affects graphical part of the window. The value in its numeric field  $U_n$  ( $I_n$ ) indicating an amplitude ratio of a harmonic is still displayed and edited in linear scale (% of the 1st harmonic).

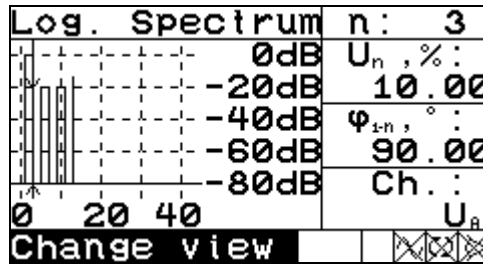

Fig. 4.12. “Waveshape” window with logarithmic spectrum of amplitudes

**Harmonics Phase Shift**

The “Harmonics Phase Shift” option (Fig. 4.13) displays the spectrogram reflecting phase shifts of harmonics with respect to the first (fundamental) harmonic.

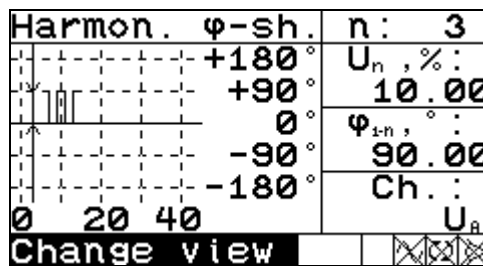

Fig. 4.13. “Harmonics Phase Shift” window with spectrum of phase shift angles

In the “Linear spectrum”, “Logarithmic spectrum” and “Harmonics phase shift” windows you can set:

- $n$  – the number of the harmonic; in the graph, the cursor moves to the spectral line associated with the selected harmonic
- $U_n$  or  $I_n$  – the amplitude ratio of the harmonic (% of the fundamental)
- $\varphi_{1-n}$  – the relative phase of the harmonic, which reflects the phase shift of the selected harmonic with respect to the fundamental.

The channel, for which the signal is created, is set in the “Oscilloscope” window.

**Setting RMS values of the 1<sup>st</sup> harmonics of output waveforms**

The “RMS values” option of the “Special signals” submenu opens the window (Fig. 4.14) where you can set the desired RMS value of the first harmonic of each output waveform.

There are 6 fields that correspond to six channels of the Generator. The fields dedicated to voltage channels can accept values 0 to 268V (in 0.001V steps); these standing for current channels can be changed within 0 to 8A range in 0.00001A steps.

RMS 1st harmonics:		
U <sub>A</sub> :	70.000	V
U <sub>B</sub> :	70.000	V
U <sub>C</sub> :	70.000	V
I <sub>A</sub> :	0.50000	A
I <sub>B</sub> :	0.50000	A
I <sub>C</sub> :	0.50000	A

60V 220V  
0.50A Pro-0.50A

Fig. 4.14. "RMS values" window

#### Turning "Interharmonics" on/off

To turn the "Interharmonics" mode on/off, select the corresponding option in the "Programmed waveform" menu and press ENT: the ON or OFF status will appear to the right of the field.

**Note:** When the mode is set to ON, the time of recalculation will be longer.

#### 4.2.4.2. "Subharmonics" mode

In the "Subharmonics" mode, the standard waveforms of the type shown in Fig. 4.15 can be set on the Generator's current outputs I<sub>A</sub>, I<sub>B</sub>, I<sub>C</sub>.

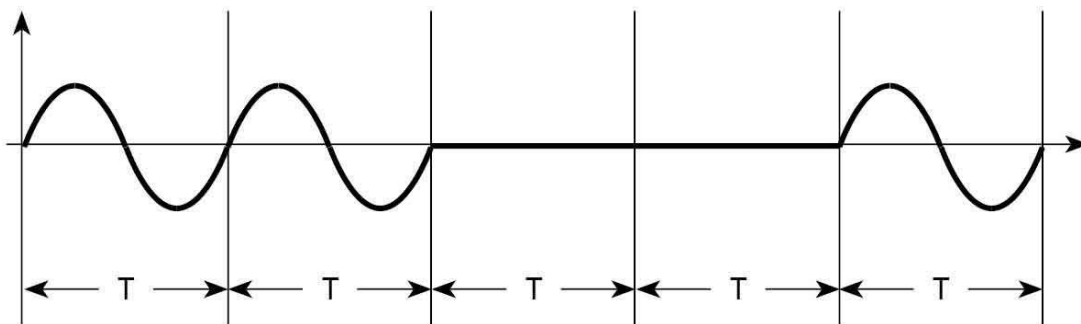

Fig. 4.15 Waveform generated in the "Subharmonics" mode (with period T)

You can use the window pictured in Fig. 4.16 to specify:

- fundamental frequency (i.e. the frequency of the first harmonic)
- phase shift between current and voltage, one and the same for each phase
- current and voltage values.

The checkboxes below I<sub>A</sub>, I<sub>B</sub>, I<sub>C</sub>  are used to turn phase currents on/off as desired. To set any of phase currents to zero, select the corresponding switch with ◀, ▶ and press ENT. The angles between phase voltages are set to 120°.

Subharmonics		
F :	50.00	Hz
AngleUI :	30.00	°
U :	70.000	V
I <sub>A</sub> I <sub>B</sub> I <sub>C</sub> :	0.50000	A
<input checked="" type="checkbox"/> <input checked="" type="checkbox"/> <input checked="" type="checkbox"/>		

60V 220V  
0.50A Pro-0.50A

Fig. 4.16 "Subharmonics" window

### 4.2.4.3. Phase control mode

The “Phase Control” window makes it possible to configure the outputs IA, IB, IC to generate standard waveforms of the type shown below with a period T (see Fig 4.17).

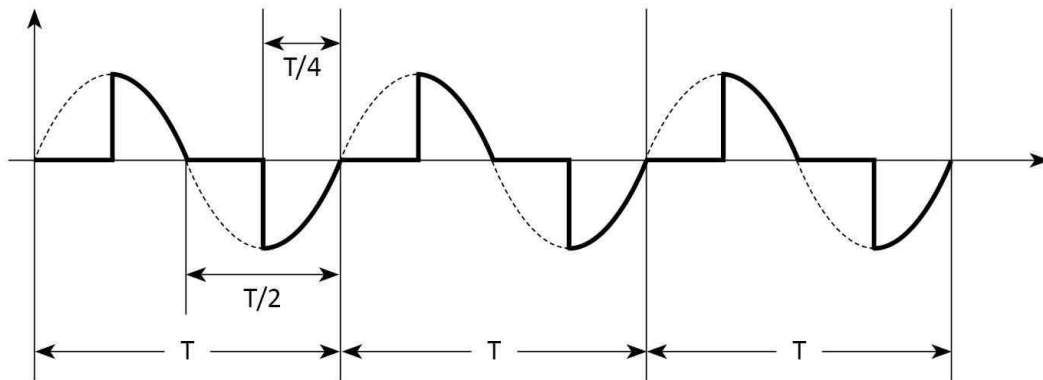

Fig. 4.17 Shape of a signal generated in the “Phase Control” mode

You can use the window pictured on Fig. 4.18 to specify:

- fundamental frequency (i.e. the frequency of the first harmonic)
- phase shift between current and voltage, one and the same for each phase
- current and voltage values

The checkboxes below IA, IB, IC  are used to turn phase currents on/off as desired. To set any of phase currents to zero, select the corresponding switch with ◀, ▶ and press ENT. The angles between phase voltages are set to 120°.

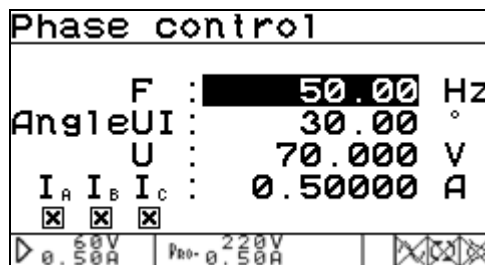

Fig. 4.18 “Phase control” window

### 4.2.4.4. “Dips and swells” mode

The window pictured in Fig. 4.19 is used to configure the sequence of dips and/or swells (referred to as “the events”) to be introduced in the output voltage waveforms UA, UB, UC. To start a sequence of events, specify their parameters, activate the status line with the ‘F’ key, and select the “regeneration”  icon. On pressing ENT, the sequence will be applied to the fundamental waveform.

Parameters of the events:

- n – the total number of events; 0 to 100 000
- t – the duration of one event; 0 to 600 s (in 0.001 s steps)
- T – the event repetition period (interval between the start points of two adjacent events) ; 0 to 600 s (in 0.001s steps); T cannot be less than t
- tn – the time delay (in seconds) between the moment when the operator starts the sequence of events by pressing  and the start of the first event; 0 to 600s, 0.001s increments)
- φn – the phase shift (in angle degrees) of the sequence of events with respect to the fundamental waveform (–179.99° to 180.00° in 0.01° increments)



- “½ T base” checkbox – when marked, the half-cycle referencing function is on, and the sequence of dips/swells is synchronized with half-cycles of the fundamental waveform (*this kind of synchronization is recommended in conjunction with the aforesaid “phase shift of the event” ( $\varphi_n$  other than zero).*)
- UA, UB, UC – fields for specifying depth of dips ( $U_n < 100\%$ ) or height of swells ( $U_n > 100\%$ ); 0 to 200% in 0.01% increments.

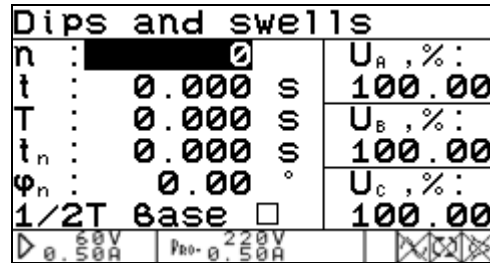

Fig. 4.19. “Dips and swells” window

In the “Dips and swells” mode, the voltage range is always set to 220V.

#### 4.2.4.5. Flicker Mode

Meander-like waveforms are generated on the voltage outputs UA, UB, UC. The characteristics of the waveforms are listed in the table below.

Number of signal	Number of variations per minute	Relative change in voltage $\Delta U/U$ , %
1	1	2.720
2	2	2.210
3	7	1.460
4	39	0.905
5	110	0.725
6	1620	0.402

The waveform to be generated is determined by its number (from 1 to 6 according to the table above) selected in the corresponding field (see Fig. 4.20) and by the multiplier (applied to  $\Delta U/U$ ). The multiplier can be set within the range of 0.01 to 25.00 in 0.01 increments.

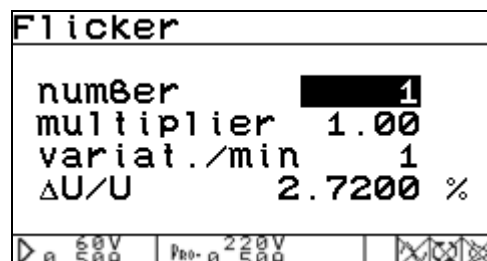

Fig. 4.20 “Flicker” mode

#### 4.2.4.6. “Signal Library” menu

See section 4.2.6.

### 4.2.5. Energoforma 3.1 - Settings menu

The “Settings” menu (Fig. 4.21) includes two options:

- RS-232 Speed
- Language

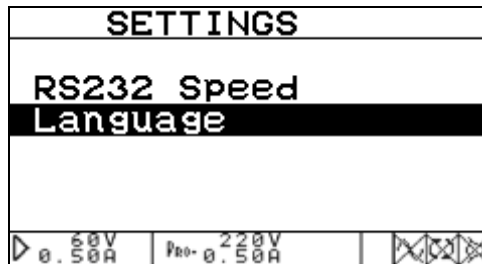

Fig. 4.21 Settings menu

#### 4.2.5.1. RS-232 Speed

The rate of data transfer to/from a PC via RS-232 can be selected among 115 200, 38 400, 19 200, and 9600 bit/s. The value you have entered appears on the upper line of the screen.

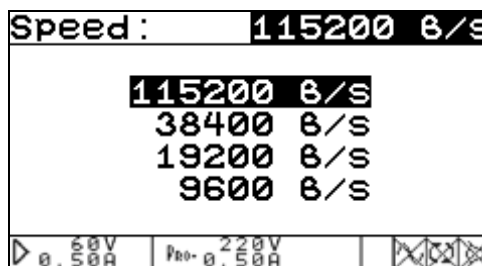

Fig. 4.22 “Data rate” selection menu

#### 4.2.5.2. Language

The language is selected with ▲, ▼ keys confirmed by ENT.

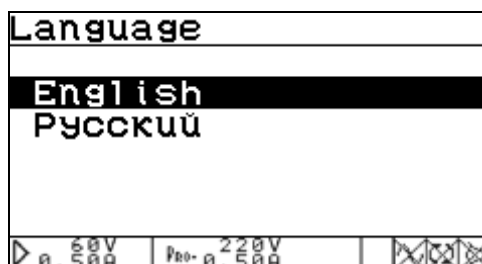

Fig. 4.23. “Language” window

### 4.2.6. Energoforma 3.1 - Signal Library Menu

Signal Library menu (Fig. 4.24) includes two options:

- Load signal
- Save signal

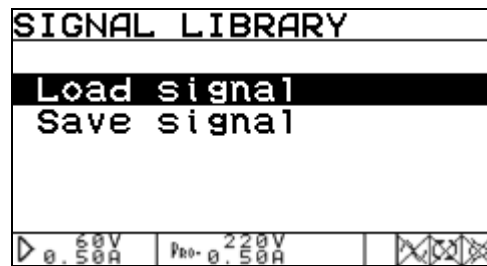

Fig. 4.24. "Signal library" menu

Either option will call up a submenu named "Select library" (Fig. 4.25). There are 12 libraries with the capacity of 10 test signals per each. The submenu occupies two pages pictured below.

- ◀, ▶ keys are used to list the pages
- ▲, ▼ keys are used to select a library name

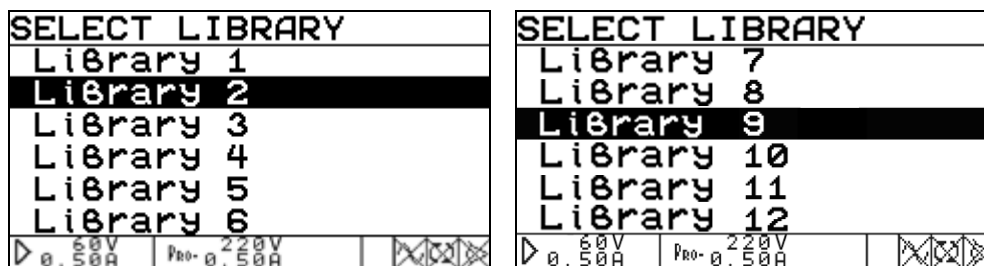

Fig. 4.25 "Select library" submenu (pages 1 and 2)

Each library contains the "Select signal" menu where names of 10 signals stored in it are listed (Fig. 4.26). Vacant positions (that store no signals at the moment) show "No data" instead of a signal name.

- ▲, ▼ keys are used to page through the signals
- ◀, ▶ keys are used to select a signal

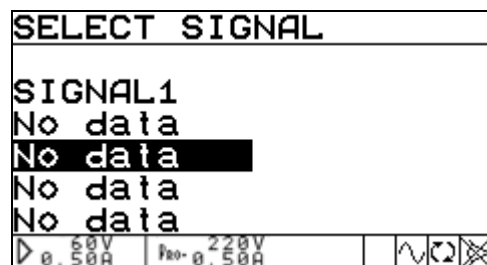

Fig. 4.26. "Select signal" submenu (page 1)

If the library was opened from the "Load signal" menu, the selected signal will be loaded to the "Programmed waveform" menu. Its profile data will be displayed on the screen pictured on Fig. 4.27.

Load signal		
SIGNAL1		
	I, A	U, V
A	0.50000	70.000
B	0.50000	70.000
C	0.50000	70.000
Freq. : 50.00 Hz		

Fig. 4.27 Signal profile window

If the library was opened from the “Save signal” option, you will see the screen where you can name the signal to be saved (Fig. 4.28).

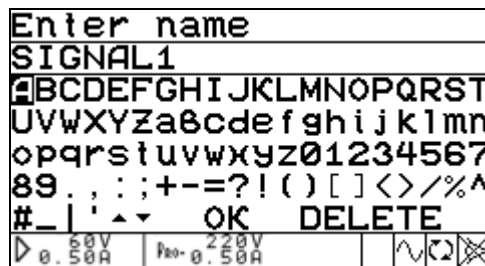

Fig. 4.28 Signal name entry window

The name of a signal must contain 20 characters or less.

▲, ▼, ◀, ▶ keys are used to select a character.

On pressing ENT, the character is added to a new signal name.

The DELETE option will delete the last character from the name.

As soon as the desired signal name has been entered, select the OK on-screen option, and then press ENT to save the name.

## 5. TECHNICAL SUPPORT

If while operating the test system or any of its units or software, you have faced some problems, try first of all to find the answers in the documentation available (help files or user manuals).

Should you still need help after reviewing all of the available materials, please contact our Technical Support group.

Manufacturer's address (for technical support and warranty claims):

### **Mars-Energo**

V.O. 13 Line, 6 - 8, office 41H, St. Petersburg, Russia

Tel/Fax: (812) 327-21-11, (812) 331-87-35 (812) 334-72-41

E-mail: [mail@mars-energo.ru](mailto:mail@mars-energo.ru)

[www.mars-energo.com](http://www.mars-energo.com)

Please provide our Technical Support with the following information:

1. Contact information (your Company's name, e-mail address and the name and phone number of whom the reply may concern)
2. Software version number (see Help\About... from the menu)
3. Device info (model name, serial number and firmware version)
4. Hardware configuration of your PC (CPU, motherboard, RAM, Hard Disc Drive)
5. Software configuration and version of your operating system
6. Description of the problem, including the complete text of error message (if any)
7. Other information that you consider to be important.

# APPENDIX A CONNECTION DIAGRAMS



Fig.A.1 Connecting IVD-3.1 to the test system

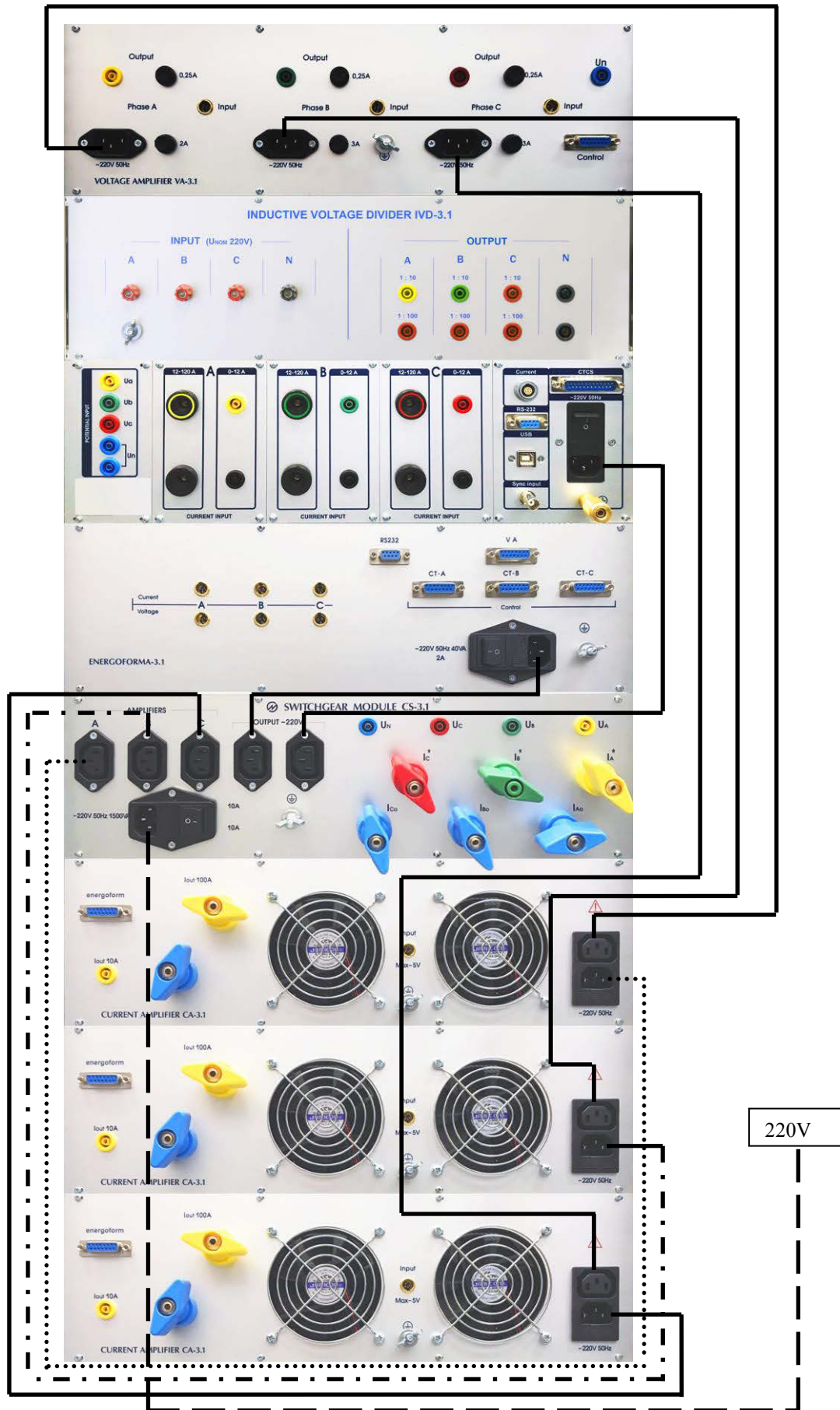

Fig.A.2 Power supply connections



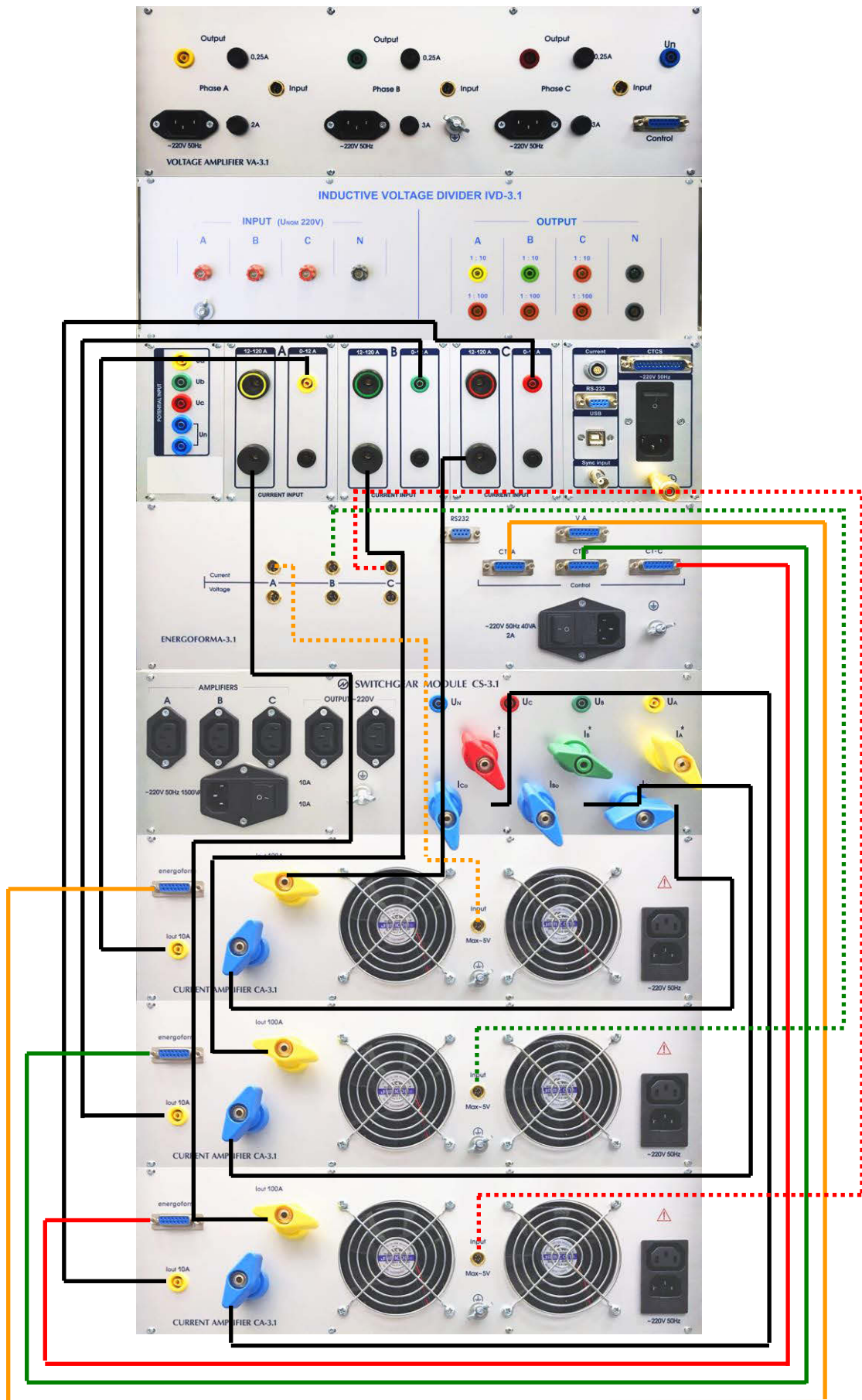

Fig.A.3. Connecting current amplifiers CA-3.1 to the test system



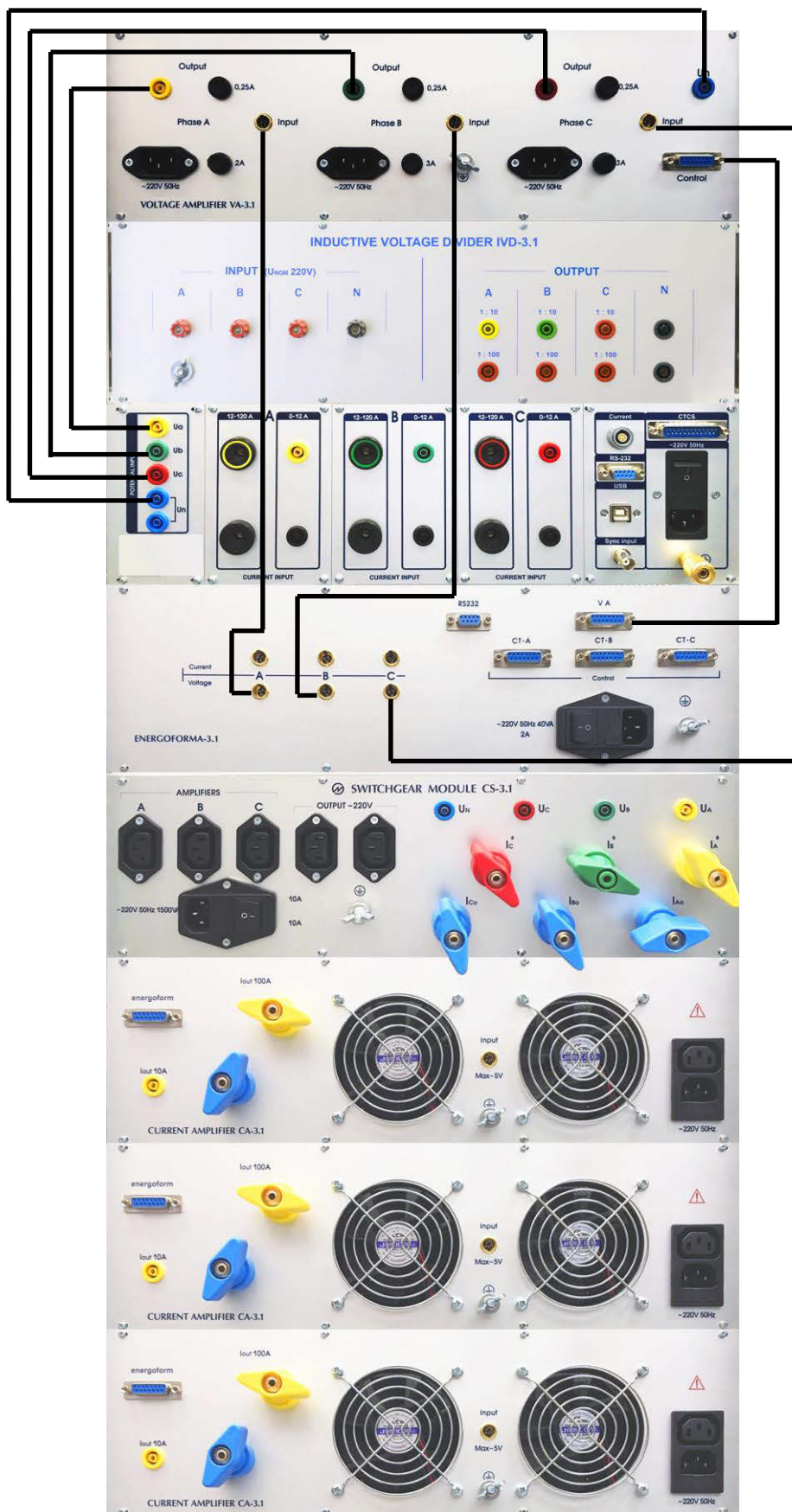

Fig.A.4 Connecting voltage amplifier VA-3.1 to the test system

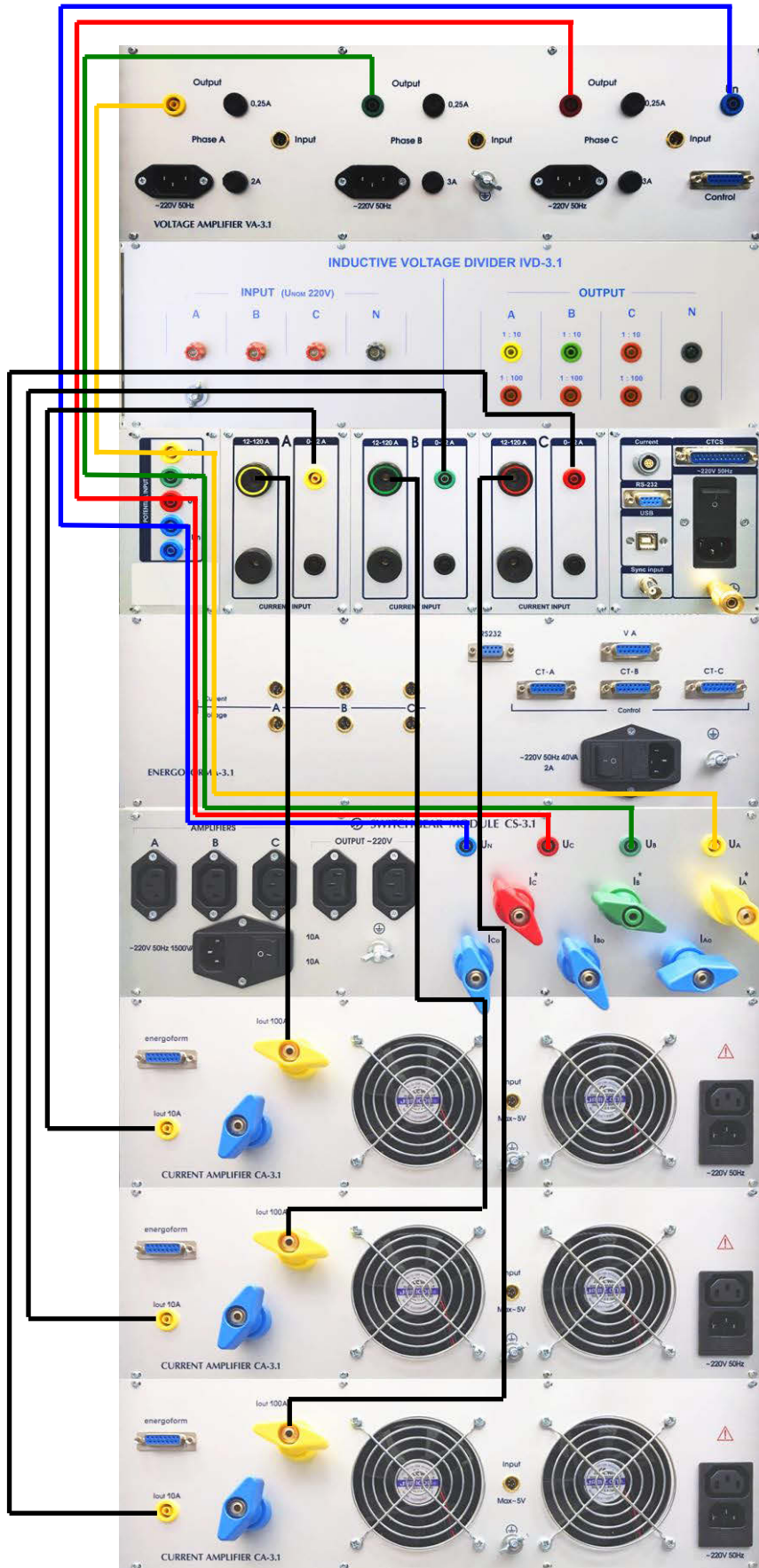
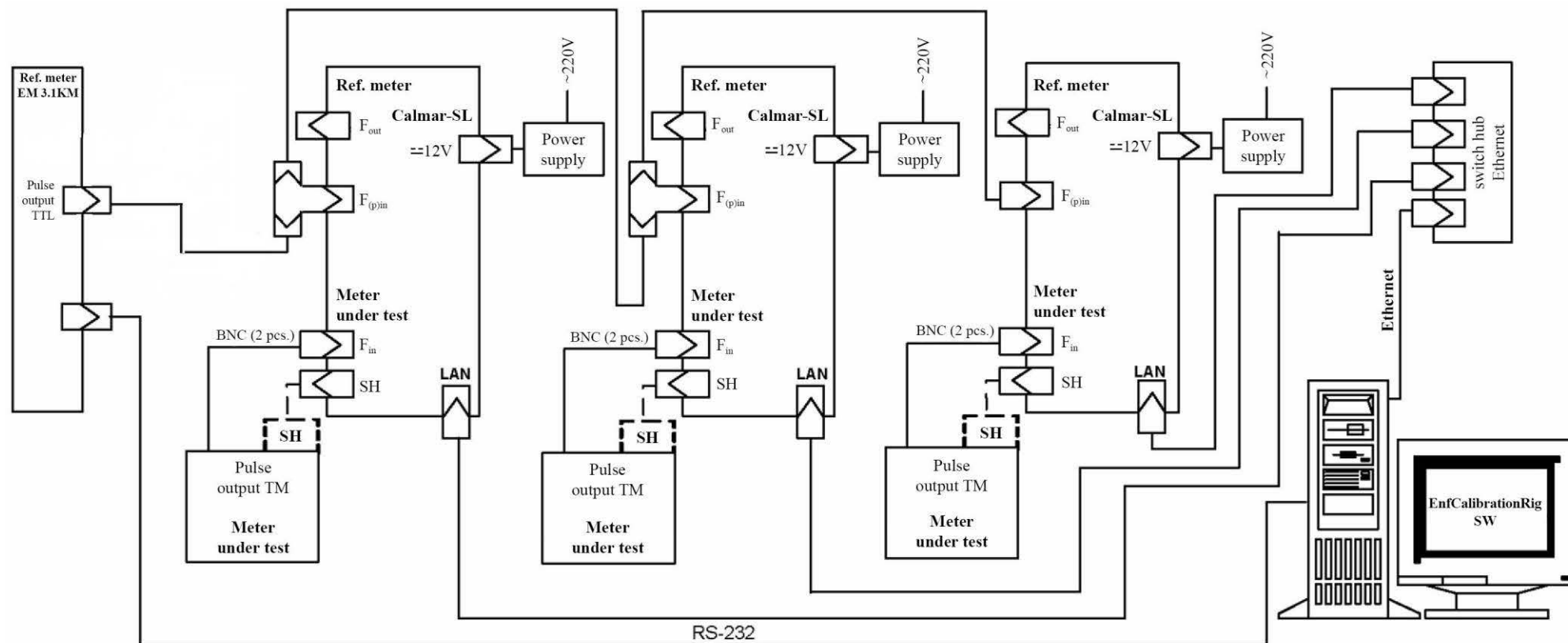

Fig.A.5 Connecting Energomonitor 3.1KM to the test system

## APPENDIX B

### 3-POSITION AUTOMATIC TEST SYSTEM



**Fig.B1** Meters under test and error calculation units Calmar-SL connected to a 3-position test system for automatic testing

## APPENDIX C SOFTWARE

Energoforma software package includes the following programs:

- Enform
- EnfCalibrationRig
- EmCounter

Each program is described in detail in the corresponding user's manual.

### **Enform**

The EnForm program is a PC-oriented software component designed to work with:

- Reference standards Energomonitor 3.3T1 (EM3.3T1) or Energomonitor 3.1KM (EM 3.1KM)
- Energoforma 3.3 waveform generator

Functions:

- Reads measurement results from the reference instrument (EM 3.1KM) via a serial port and displays the results on a PC screen
- Activates required measurement ranges in the reference instrument upon user command
- Sends commands to the generator to generate preset test signals (test sequences) and corrects generated signals on the basis of reference meter readings
- Supports accuracy testing and calibration of digital and pointer-type measuring instruments in the manual mode
- Generates user-specified test reports
- Supports accuracy testing and calibration of Energomonitor-type reference instruments in the automatic mode
- Saves (recalls) test signals and test sequences to (from) files on the hard disc
- Maintains libraries of test signals

### **EnfCalibrationRig**

The program supports accuracy testing and calibration of instruments measuring electrical quantities and power quality parameters on the MTS ME 3.1KM test system in the automatic mode. The automatic mode is provided by controlling the Energomonitor 3.1KM (reference meter), Energoforma 3.1 (waveform generator) and Calmar-SL (error calculators) connected in a LAN.

Functions:

- Supports testing of single- and 3-phase electric energy meters (up to 3 meters) in the automatic mode (on the test system complete with Calmar-SL units)
- Supports testing of single- and 3-phase electric energy meters (up to 3 meters) in the semi-automatic mode (on the test system complete with Calmar-SL units)
- Supports testing of single- and 3-phase measuring converters with DC outputs (up to 15 converters at a time) in the automatic mode (on the test system complete with Calmar-SL units)
- Supports adjustment (calibration) of single- and 3-phase measuring converters with DC outputs (up to 15 converters at a time) in the semi-automatic mode (on the test system complete with Calmar-SL units)
- Reads test (adjustment, calibration) results from the reference meter via a serial interface and displays the results on a PC screen
- Saves (recalls) test sequences for meters and converters to (from) files on the hard disc
- Sends commands to the generator to generate preset test signals and sequences and corrects generated signals on the basis of reference meter readings

- Reads test results from Calmar-SL units via Ethernet (10Mbit/sec) and saves the data to files on the hard disc
- Displays test results on a PC in various forms and combinations
- Exports test (adjustment, calibration) results to MS Excel.

In the automatic test mode, each device under test (up to 15) is connected to an individual error calculation unit (Calmar-SL). The devices under test shall be of the same type, since they shall be connected to the test system according to one and the same connection scheme.

The test method is based on comparison of two frequencies (frequency signals from a reference meter and meter-under-test are compared).

As regards electric energy meters, the pulse output of each meter is connected to the pulse input of one Calmar-SL. The meters are tested considering the type of power (active, reactive, or apparent) measured by the meter.

When testing measuring converters, the DC output of each converter is connected to the DC current (voltage) measuring input of one Calmar-SL.

Testing (calibration, adjustment) of DC output converters of the following types is supported:

Input: AC voltage, AC current, active power, reactive power, apparent power, phase and frequency

DC output: [0 ... +5] V; [0 ... +10] V; [-5 ... +5] V; [-10 ... +10] V; [0 ... +20] mA; [+4 ... +20] mA; [0 ... +5] mA; [-5 ... +5] mA.

Refer to the Calmar-SL user's manual for connections between the Calmar-SL, test system modules and device under test.

Refer to the EnfCalibrationRig user's manual for the description of the program.

### **EmCounter**

EmCounter is a PC-oriented software component intended for work with:

- Portable reference standard and power quality analyzer Energomonitor 3.3T1 (EM3.3T1)
- Multifunctional reference standard Energomonitor 3.1KM (EM 3.1KM)

The program makes it possible to:

- read, via serial RS-232 and USB ports, logs of test results, accumulated in the reference instrument
- save logs of test results on the hard disc
- merge logs of test results made for one particular meter (device under test)
- view previously recorded data in a convenient way
- create test reports that can be printed or saved to files on the hard disc
- create and maintain databases of devices under test and store the databases in files on the hard disk
- export test results to MS Excel